

KOMATSU®

PC300-7 PC300LC-7

FLYWHEEL HORSEPOWER
180 kW 242 HP @ 1900 rpm

OPERATING WEIGHT
PC300-7: 30800–31510 kg
67,900–69,470 lb
PC300LC-7: 31520–32280 kg
69,490–71,160 lb



**PC
300**

HYDRAULIC EXCAVATOR



Photo may include optional equipment.



WALK-AROUND

FLYWHEEL HORSEPOWER
180 kW 242 HP @ 1900 rpm

OPERATING WEIGHT
PC300-7: 30800 – 31510 kg
67,900 – 69,470 lb
PC300LC-7: 31520 – 32280 kg
69,490 – 71,160 lb

BUCKET CAPACITY
0.52 – 1.80 m³
0.68 – 2.35 yd³

Productivity Features

- **High Production and Low Fuel Consumption**

Production is increased with larger output during Active mode while fuel efficiency is further improved.

- **Maximum Drawbar Pull**

is increased 17% offering superb steering and slope climbing performance.

See page 4



Easy Maintenance

- Replacement interval is extended for engine oil, engine oil filter and hydraulic filter
- Remote mounted engine oil filter and fuel drain valve for easy access
- Water separator is standard equipment
- Easier radiator cleaning
- Fuel tank capacity is increased
- BMRC bushings on work equipment extend lubricating interval (optional)

See pages 8 and 9

Harmony with Environment

- Low emission engine
A powerful turbocharged and air to air aftercooled Komatsu SAA6D114E provides **180 kW** 242 HP.
- Economy mode saves fuel consumption
- Low operation noise
- Easily recycled design

See page 5

Large Comfortable Cab

New PC300-7's cab volume is increased by 14%, offering an exceptionally roomy operating environment

- Highly pressurized cab with optional air conditioner
- Low noise design
- Low vibration with cab damper mounting
- FOG capable with optional bolt-on top guard

FOG has been renamed to OPG (Operator Protective Guards) top guard level 2 by ISO 10262

See page 6

- **Larger Arm Crowd Force and Bucket Digging Force Provide Increased Production**

Arm crowd force is increased 18% and bucket digging force is increased 7% when the Power Max function is applied. (Compared with PC300-6).

See page 4

- **Higher Lifting Capacity**

PC300-7's lateral stability is improved, lifting capacity also increased.

Excellent Reliability and Durability

- High rigidity work equipment
- Sturdy frame structure
- Reliable Komatsu manufactured major components
- Highly reliable electronic devices

See page 5

Photo may include optional equipment.

PRODUCTIVITY FEATURES



High Production and Low Fuel Consumption

The increased output and fuel savings of the Komatsu SAA6D114E engine result in increased production and improved production per unit of fuel.

Engine

The PC300-7 gets its exceptional power and work capacity from a Komatsu SAA6D114E engine. Output is **180 kW** 242 HP, providing increased hydraulic power and improved fuel efficiency.

Hydraulics

Unique two-pump system ensures smooth compound movement of the work equipment. HydraMind controls both pumps for efficient engine power use. This system also reduces hydraulic loss during operation.

Three Working Modes

Working Mode Selection

The PC300-7 excavator is equipped with three working modes (A, E and B mode). Each mode is designed to match engine speed, pump speed, and system pressure with the current application. This provides the flexibility to match equipment performance to the job at hand.

Working Mode	Application	Advantage
A	Active mode	<ul style="list-style-type: none"> Maximum production/power Fast cycle times
E	Economy mode	<ul style="list-style-type: none"> Excellent fuel economy
B	Breaker operation	<ul style="list-style-type: none"> Optimum engine rpm, hydraulic flow

Large Lifting Capacity

PC300-7's lateral stability is improved resulting in increased lifting capacity.

Larger Maximum Drawbar Pull

17% increased

PC300-7's maximum drawbar pull is increased by 17% and provides superb steering and slope climbing performance. Maximum drawbar pull: 264 kN **26900 kgf** 59,300 lb. Drawbar pull/operating weight: 0.87

Larger Arm Crowd Force and Digging Force Provide Increased Production

Arm crowd force is increased **10%** by improvement of arm cylinder linkage; when Power Max function is applied, arm crowd force is increased by an additional **7%**. As a result the total arm crowd force is increased **18%**.

Bucket digging force when Power Max is applied also increased **7%**. The larger digging forces generated the largest production in the **30 ton** 33 U.S. ton class.

- *Arm Crowd Force: 171 kN **17400 kgf** 38,360 lb.
- *Bucket Digging Force: 227 kN **23100 kgf** 50,930 lb.

*Measured with Power Max function, 3185 mm 10'5" and ISO rating

Smooth Loading Operation

Two return hoses

Two return hoses improve hydraulic performance. In the arm out function, a portion of the oil is returned to the tank smoothly.



Economy Mode

Economy mode is environmentally friendly. Fuel consumption is reduced 20% (compared with PC300-7 Active mode) and production is equal to the PC300-6 heavy duty mode.

Two Boom Settings

Smooth mode provides easy operation for gathering blasted rock or scraping down operation. When maximum digging force is needed, switch to Power mode for more effective excavating.

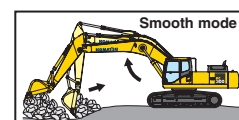

Boom floats upward, reducing lifting of machine front. This facilitates gathering blasted rock and scraping down operations.

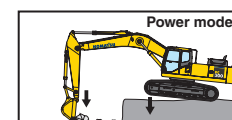

Boom pushing force is increased, ditch digging and box digging operation on hard ground are improved.

Excellent Reliability and Durability

High Rigidity Work Equipment

The arm and boom are strengthened to correspond to increasing bucket and arm digging forces. The arm and boom cross sectional strength are also increased 35% and 9% respectively. The boom and arm have large cross-sectional dimensions as well as continuous groove welding, improving digging and side contact strength.

Sturdy Frame Structure

The revolving frame, center frame and undercarriage are designed by using the most advanced three-dimensional CAD and FEM analysis technology.

Reliable Components

All of the major machine components, such as engine, hydraulic pumps, hydraulic motors and control valves, etc., are exclusively designed and manufactured by Komatsu.

Highly Reliable Electronic Devices

Exclusively designed electronic devices have passed severe testing.

- Controller
- Sensors
- Connectors
- Heat resistant wiring

Metal guard rings protect all the hydraulic cylinders and improve reliability.

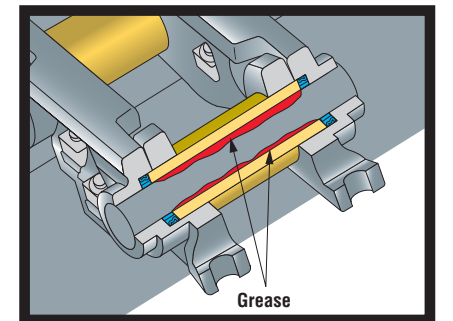
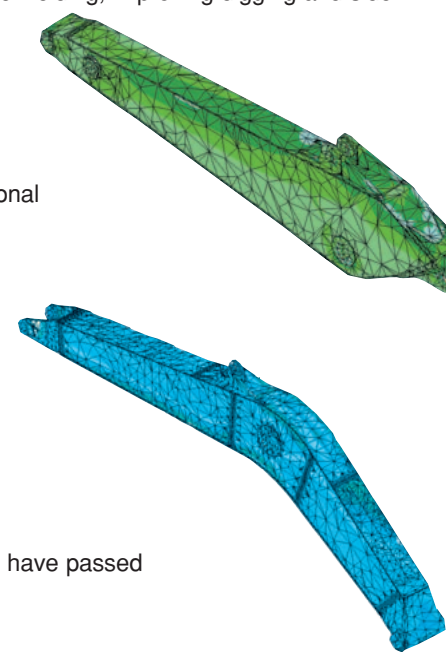

Grease Sealed Track
PC300-7 uses grease sealed tracks for extended undercarriage life.

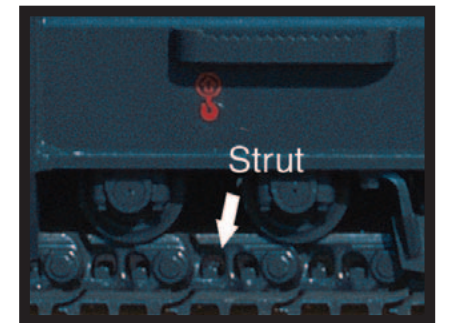

Track Link with Strut
PC300-7 uses track links with strut providing superb durability

Harmony with Environment

Low Noise

Noise is reduced not only from the engine but also during swing and hydraulic relief. Dynamic noise level is 106 dB.

Environment Oriented Mode (Economy Mode)

Economy mode meets the needs of the 21st century. Economy mode offers the user fuel savings, quiet operation and less CO₂ emission.

- Fuel consumption is reduced 20% (compared with Active mode).
- Production is the same as the PC300-6 heavy duty mode.

Easily Recycled

PC300-7 is designed with consideration of recycling and uses natural resources effectively.

- Sound suppressing material is made from PET (polyethylene terephthalate) resin that is easy to recycle.
- All exterior parts are made from steel.
- Engine and hydraulic system oil and filter replacement intervals are extended to save earth resources.
- All resin-made parts are indicated by material code symbol.

WORKING ENVIRONMENT

PC300-7 cab interior is spacious and provides a comfortable working environment...

Large Comfortable Cab

Comfortable Cab

New PC300-7's cab volume is increased by 14%, offering an exceptionally comfortable operating environment. The large cab enables full flat reclining of the seat back with headrest.

Pressurized Cab

With optional air conditioner, air filter and a higher internal air pressure (6.0 mm Aq 0.2" Aq) prevent external dust from entering the cab.

Low Noise Design

Noise level is remarkably reduced, not only engine noise but also noise when swinging and hydraulic relief.

Low Vibration with Cab Damper Mounting

PC300-7 uses new, improved cab damper mount system that incorporates longer stroke and the addition of a spring. The new cab damper mounting combined with a strengthened left and right side deck aids vibration reduction at operator seat.

Vibration at floor is reduced from 120 dB (VL) to 115 dB (VL).

dB (VL) is index for expressing size of vibration.

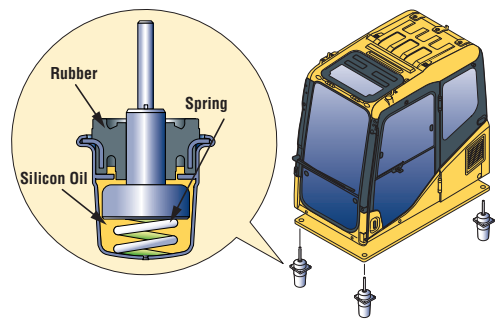

Comparison of Riding Comfort

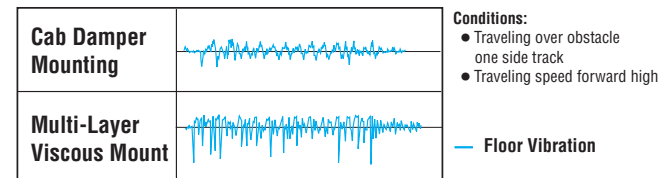

Pitch vertical direction on graph shows size of vibration.



Automatic Air Conditioner (optional)

A 6,900 kcal air conditioner is utilized. The bi-level control function keeps the operator's head and feet cool and warm respectively. This improved air flow function keeps the inside of the cab comfortable throughout the year.

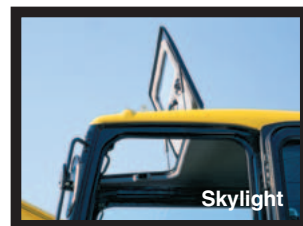
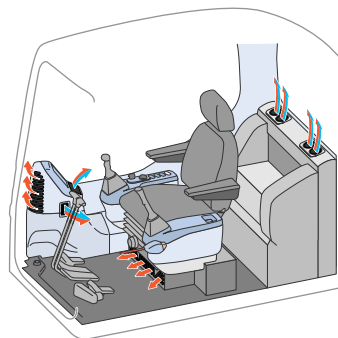

Washable Cab Floormat
The PC300-7's cab floormat is easy to keep clean. The gently inclined surface has a flanged floormat and drainage holes to facilitate runoff.



Multi-Position Controls

The multi-position, pressure proportional control levers allow the operator to work in comfort while maintaining precise control. A double-slide mechanism allows the seat and controllers to move together or independently, allowing the operator to position the controllers for maximum productivity and comfort.



Seat Sliding Amount: 340 mm 13.4", increased 120 mm 4.7"



Safety Features

Cab

FOG capable with optional bolt-on top guard.

Wide Visibility

The right side window pillar has been removed and the rear pillar reshaped to provide better visibility. Blind spots have been decreased by 34%.

Pump/engine room partition

prevents oil from spraying on the engine if a hydraulic hose should burst.

Thermal and fan guards are placed around high-temperature parts of the engine and fan drive.

Steps with non-skid sheet and large handrail. Steps with non-skid sheet provide anti-slip footing for maintenance.



Large Handrail

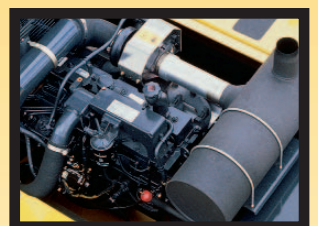

Thermal Guard

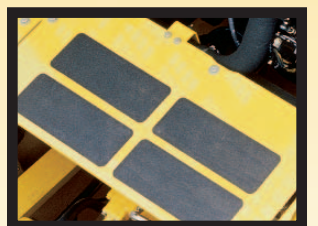

Non-skid Sheet

MAINTENANCE FEATURES

Self-Diagnostic Monitor

The PC300-7 features the most advanced diagnostics system in the industry. The Komatsu exclusive system identifies maintenance items, reduces diagnostic times, indicates oil and filter replacement hours and displays error codes.

Continuous Machine Monitoring System

When turning starting switch ON, Check-before-starting item and caution items appear on the liquid crystal panel. If abnormalities are found, a warning lamp blinks and a warning buzzer sounds. The continuous machine condition checks help prevent the development of serious problems and allows the operator to concentrate on the controls.

Abnormalities on Electronic System Display with Code

When an error occurs during operation, a user code is displayed. When an important user code is displayed, a caution lamp blinks and a warning buzzer sounds to prevent the development of serious problems.

Oil Maintenance Function

When machine exceeds oil or filter replacement time, oil maintenance monitor lights to inform operator.

Easy Maintenance

Komatsu designed the PC300-7 to have easy service access. We know by doing this, routine maintenance and servicing are less likely to be skipped, which can mean a reduction in costly downtime later on. Here are some of the many service features found on the PC300-7.

• Easy Radiator Cleaning

Clearance between radiator and oil cooler is increased to facilitate radiator core cleaning with an air nozzle.



• **Water Separator and Corrosion Resistor** are standard equipment, removing water mixed in fuel and preventing fuel and cooling systems damage.

• **Self-diagnostic Monitor** allows display of vital self-diagnosis, as well as displaying up to 39 different faults.

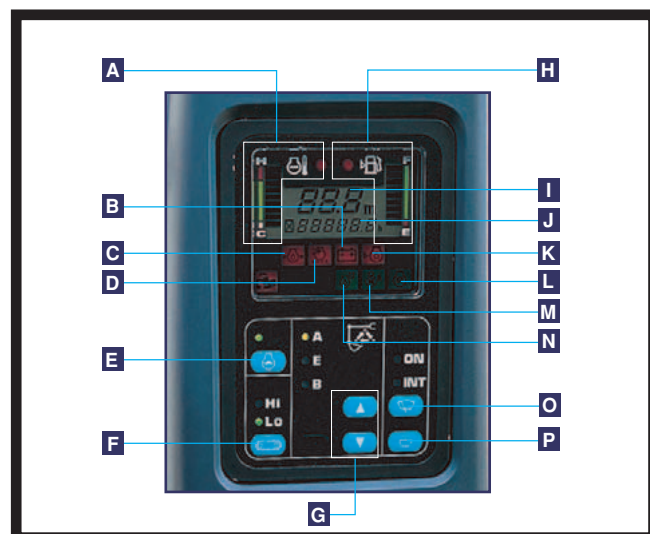

- A Engine Water Temperature
- B Battery Charge
- C Engine Oil Pressure
- D Air Cleaner Clogging Monitor
- E Auto-Decel Switch
- F Travel Speed Select Switch
- G Working Mode Select Switch
- H Fuel Level Monitor
- I User or Trouble Code Display
- J Service Meter Display
- K Engine Oil Level
- L Engine Preheat
- M Swing Lock Display
- N Oil Maintenance
- O Windshield Wiper Switch
- P Windshield Washer Switch

• **Easy Access to Engine Oil Filter and Fuel Drain Valve**
Engine oil filter and fuel drain valve are remotely mounted to improve accessibility.



Reducing Maintenance Costs

• **Hydraulic Oil and Filter/Engine Oil and Filter Replacement Interval Extended**

The new high performance filters are used in hydraulic circuit and engine. Hydraulic oil filter, engine oil, and engine oil filter element replacement intervals are significantly extended to reduce maintenance costs.

	unit: hours	
Comparison of Replacement Intervals	PC300-7	PC300-6
Engine oil	500	250
Engine oil filter	500	250
Hydraulic oil	5,000	5,000
Hydraulic oil filter	1,000	500

• **Fuel Tank Capacity Increased**

Fuel tank capacity is increased from **540 ltr** 142.7 U.S. gal to **605 ltr** 160.0 U.S. gal to extend operating hours before refueling. Fuel tank is treated for rust prevention and improved corrosion resistance.

OPTIONS TO UPDATE THE VALUE

Multi-Function Color Monitor

A newly developed Multi-Function Color Monitor has multiple functions, such as Working mode selection, hydraulic pump oil flow adjustment for matching to attachment, and maintenance interval notice, etc.

Working Mode Selection

The Multi-Function Color Monitor has **Lifting mode** in addition to the standard three-mode selection (A, E, and B modes).

Working Mode	Application	Advantage
A	Active mode	<ul style="list-style-type: none"> • Maximum production/power • Fast cycle times
E	Economy mode	<ul style="list-style-type: none"> • Excellent fuel economy
L	Lifting mode	<ul style="list-style-type: none"> • Hydraulic pressure is increased by 7%
B	Breaker operation	<ul style="list-style-type: none"> • Optimum engine rpm, hydraulic flow

Hydraulic Pump Oil Flow Adjustment System

When installing attachments (breaker, crusher, etc.) and B, A, or E mode is selected, it is possible to adjust engine and hydraulic pump discharge flow to match attachment characteristics. Selection is possible throughout the LCD (Liquid Crystal Display). This system also allows throttling of the attachment side discharge flow to provide smooth work equipment movement and compound operation with work equipment and attachment.

Maintenance Costs Reduced

Work Equipment Lubrication Intervals Are Extended with Optional BMRC Bushings

Newly developed BMRC bushings are used on the work equipment. All bushing lubrication intervals of work equipment are extended reducing maintenance costs. (except bucket pin bushings)

Work Equipment Lubrication Interval	unit: hours	
	PC300-7	PC300-6
Boom foot and boom cylinder bottom bushings	500	50
Other bushings*	500	100

(*: except bucket pin bushings)

Automatic Three-Travel Speed

Travel speed is automatically shifted from high to low speed according to the pressure of the travel. This optional system is available as part of the Multi-Function Color Monitor.

	High	Mid	Low
Travel Speed	5.5 km/h 3.4 mph	4.5 km/h 2.8 mph	3.2 km/h 2.0 mph

Lifting Mode

When the Lifting mode is selected, lifting capacity is increased by 7% by raising hydraulic pressure.

EMMS (Equipment Management Monitoring System)

Monitor Function

Controller monitors engine oil level, coolant level, engine oil pressure, coolant temperature, battery charge and air cleaner clogging, etc. If controller finds any abnormality, it is displayed on the LCD.

Maintenance Function

Monitor informs replacement time of oil and filters on LCD when the replacement interval is reached.

Trouble Data Memory Function

Monitor stores abnormalities for effective troubleshooting.

BMRC (Beta Matrix Reinforced Copper Alloy)

A bushing made by combining a sintered copper layer impregnated with oil for better fitting and a backing metal. It is used for severe application parts which receive low rocking stresses and high loads to prevent creaking and scuffing because of its excellent sliding characteristics.

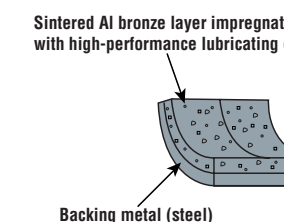

Resin Made Shim

Resin made shims are used for work equipment pin connections (except bucket connections) to reduce noise.



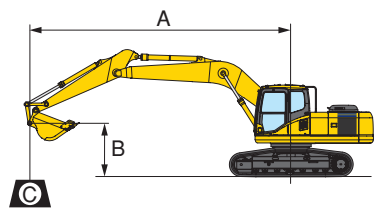

A: Reach from swing center
 B: Bucket hook height
 C: Lifting capacity
 Cf: Rating over front
 Cs: Rating over side
 ●: Rating at maximum reach

PC300-7		Arm: 3185 mm 10'5"		Bucket: 1.40 m³ 1.83 yd³ SAE heaped		Shoe: 600 mm 23.6" triple grouser		9.1 m 30'		7.6 m 25'		6.1 m 20'		4.6 m 15'		3.0 m 10'		
B	A	MAX		Cf	Cs	Cf	Cs	Cf	Cs	Cf	Cs	Cf	Cs	Cf	Cs	Cf	Cs	
		Cf	Cs															
7.6 m 25'		*4600 kg *10,100 lb	*4600 kg *10,100 lb			*5950 kg *13,200 lb	5200 kg 11,500 lb											
6.1 m 20'		*4500 kg *9,900 lb	3750 kg 8,300 lb			*6550 kg *14,400 lb	5200 kg 11,400 lb											
4.6 m 15'		*4600 kg *10,100 lb	3250 kg 7,200 lb	5200 kg 11,500 lb	3500 kg 7,700 lb	*7050 kg *15,500 lb	5000 kg 11,000 lb	*8150 kg *18,000 lb	7400 kg 16,300 lb									
3.0 m 10'		4500 kg 9,900 lb	2950 kg 6,500 lb	5100 kg 11,200 lb	3350 kg 7,400 lb	*6950 kg *15,300 lb	4700 kg 10,400 lb	*9500 kg *20,900 lb	6850 kg 15,100 lb	*12650 kg *27,900 lb	10550 kg 23,300 lb							
1.5 m 5'		4350 kg 9,600 lb	2800 kg 6,200 lb	4950 kg 10,900 lb	3250 kg 7,100 lb	6700 kg 14,800 lb	4450 kg 9,800 lb	9550 kg 21,100 lb	6350 kg 14,000 lb	*14800 kg *32,600 lb	9750 kg 21,500 lb							
0 m 0'		4450 kg 9,800 lb	2850 kg 6,300 lb	4800 kg 10,500 lb	3100 kg 6,800 lb	6450 kg 14,200 lb	4250 kg 9,400 lb	9150 kg 20,200 lb	6000 kg 13,200 lb	14600 kg 32,200 lb	9200 kg 20,300 lb	*7250 kg *16,000 lb	*7250 kg *16,000 lb					
-1.5 m -5'		4750 kg 10,500 lb	3100 kg 6,800 lb	4800 kg 10,500 lb	3100 kg 6,800 lb	6350 kg 14,000 lb	4150 kg 9,100 lb	9000 kg 19,800 lb	5800 kg 12,800 lb	14400 kg 31,700 lb	9050 kg 19,900 lb	*11750 kg *25,900 lb	*11750 kg *25,900 lb					
-3.0 m -10'		5500 kg 12,100 lb	3550 kg 7,900 lb	4800 kg 10,500 lb	3100 kg 6,800 lb	6350 kg 14,000 lb	4150 kg 9,100 lb	8950 kg 19,700 lb	5800 kg 12,800 lb	*13950 kg *30,800 lb	9100 kg 20,100 lb	*17200 kg *37,900 lb	*17200 kg *37,900 lb					
-4.6 m -15'		*6700 kg *14,700 lb	4750 kg 10,400 lb	4800 kg 10,500 lb	3100 kg 6,800 lb	6350 kg 14,000 lb	4150 kg 9,100 lb	8500 kg *18,700 lb	6000 kg 13,200 lb	*11350 kg *25,000 lb	9350 kg 20,700 lb	*16250 kg *33,600 lb	*15200 kg *33,700 lb					
-6.1 m -20'		*5600 kg *12,300 lb	*5600 kg *12,300 lb							*6750 kg *14,900 lb	*6750 kg *14,900 lb							

PC300-7		Arm: 2200 mm 7'3"		Bucket: 1.40 m³ 1.83 yd³ SAE heaped		Shoe: 600 mm 23.6" triple grouser		7.6 m 25'		6.1 m 20'		4.6 m 15'		3.0 m 10'		1.5 m 5'		
B	A	MAX		Cf	Cs	Cf	Cs	Cf	Cs	Cf	Cs	Cf	Cs	Cf	Cs	Cf	Cs	
		Cf	Cs															
7.6 m 25'		*7650 kg *16,900 lb	6400 kg 14,100 lb															
6.1 m 20'		7000 kg 15,400 lb	4800 kg 10,600 lb	7200 kg 15,900 lb	4950 kg 10,900 lb	*8200 kg *18,100 lb	7450 kg 16,400 lb											
4.6 m 15'		5950 kg 13,100 lb	4000 kg 8,800 lb	7050 kg 15,500 lb	4800 kg 10,600 lb	*9100 kg *20,100 lb	7050 kg 15,500 lb	*11750 kg *26,000 lb	11200 kg 24,700 lb									
3.0 m 10'		5350 kg 11,800 lb	3550 kg 7,800 lb	6750 kg 14,900 lb	4550 kg 10,000 lb	9700 kg 21,400 lb	6500 kg 14,300 lb	*14200 kg *31,300 lb	9900 kg 21,800 lb									
1.5 m 5'		5200 kg 11,500 lb	3400 kg 7,500 lb	6550 kg 14,400 lb	4300 kg 9,500 lb	9050 kg 20,000 lb	5900 kg 13,000 lb	14450 kg 31,900 lb	9100 kg 20,100 lb									
0 m 0'		5350 kg 11,800 lb	3450 kg 7,600 lb	6350 kg 14,000 lb	4150 kg 9,200 lb	8950 kg 19,700 lb	5800 kg 12,800 lb	14200 kg 31,300 lb	8850 kg 19,500 lb									
-1.5 m -5'		5850 kg 12,900 lb	3800 kg 8,400 lb	6350 kg 14,000 lb	4100 kg 9,100 lb	8900 kg 19,600 lb	5750 kg 12,600 lb	*14100 kg *31,100 lb	8900 kg 19,600 lb	*14200 kg *31,300 lb	*14200 kg *31,300 lb							
-3.0 m -10'		7100 kg 15,700 lb	4650 kg 10,300 lb	6350 kg 14,000 lb	4100 kg 9,100 lb	8850 kg 19,500 lb	5700 kg 12,600 lb	*12200 kg *26,900 lb	9100 kg 20,100 lb	*15100 kg *33,300 lb	*15100 kg *33,300 lb							
-4.6 m -15'		*6900 kg *15,200 lb	*6900 kg *15,200 lb					*8550 kg *18,800 lb	*8550 kg *18,800 lb									

PC300-7		Arm: 2550 mm 8'4"		Bucket: 1.40 m³ 1.83 yd³ SAE heaped		Shoe: 600 mm 23.6" triple grouser		7.6 m 25'		6.1 m 20'		4.6 m 15'		3.0 m 10'		1.5 m 5'		
B	A	MAX		Cf	Cs	Cf	Cs	Cf	Cs	Cf	Cs	Cf	Cs	Cf	Cs	Cf	Cs	
		Cf	Cs															
7.6 m 25'		*6500 kg *14,400 lb	5500 kg 12,100 lb															
6.1 m 20'		6250 kg 13,800 lb	4250 kg 9,400 lb	*7100 kg *15,700 lb	5050 kg 11,100 lb													
4.6 m 15'		5400 kg 11,900 lb	3600 kg 7,900 lb	7150 kg 15,700 lb	4850 kg 10,700 lb	*8800 kg *19,400 lb	7150 kg 15,800 lb											
3.0 m 10'		4950 kg 10,900 lb	3250 kg 7,200 lb	6850 kg 15,100 lb	4600 kg 10,100 lb	9850 kg 21,700 lb	6600 kg 14,500 lb	*13750 kg *30,300 lb	10200 kg 22,500 lb									
1.5 m 5'		4800 kg 10,600 lb	3100 kg 6,800 lb	6600 kg 14,500 lb	4350 kg 9,600 lb	9350 kg 20,600 lb	6150 kg 13,600 lb	14750 kg 32,500 lb	9350 kg 20,600 lb									
0 m 0'		4900 kg 10,800 lb	3200 kg 7,000 lb	6400 kg 14,100 lb	4200 kg 9,200 lb	9050 kg 19,900 lb	5850 kg 12,900 lb	14350 kg 31,600 lb	9000 kg 19,800 lb									
-1.5 m -5'		5350 kg 11,800 lb	3450 kg 7,600 lb	6350 kg 14,000 lb	4100 kg 9,100 lb	8900 kg 19,700 lb	5750 kg 12,700 lb	14300 kg 31,600 lb	8950 kg 19,700 lb	*12350 kg *27,200 lb	*12350 kg *27,200 lb							
-3.0 m -10'		6300 kg 13,900 lb	4100 kg 9,100 lb	6400 kg 14,100 lb	4200 kg 9,200 lb	8800 kg 19,400 lb	5650 kg 12,400 lb	*12900 kg *28,400 lb	9100 kg 20,100 lb	*16850 kg *37,200 lb	*16850 kg *37,200 lb							
-4.6 m -15'		*6600 kg *14,600 lb	5800 kg 12,800 lb			*7100 kg *15,600 lb	6100 kg 13,500 lb	*9650 kg *21,300 lb	9500 kg 20,900 lb	*12100 kg *26,700 lb	*12100 kg *26,700 lb							

PC300-7		Arm: 4020 mm 13'2"		Bucket: 1.14 m³ 1.49 yd³ SAE heaped		Shoe: 600 mm 23.6" triple grouser		9.1 m 30'		7.6 m 25'		6.1 m 20'		4.6 m 15'		3.0 m 10'		
B	A	MAX		Cf	Cs	Cf	Cs	Cf	Cs	Cf	Cs	Cf	Cs	Cf	Cs	Cf	Cs	
		Cf	Cs															
7.6 m 25'		*3550 kg *7,900 lb	*3550 kg *7,900 lb															
6.1 m 20'		*3500 kg *7,700 lb	3200 kg 7,000 lb	*5350 kg *11,800 lb	3750 kg 8,300 lb													
4.6 m 15'		*3550 kg *7,800 lb	2800 kg 6,200 lb	5400 kg 11,900 lb	3650 kg 8,100 lb	*6400 kg *14,100 lb	5200 kg 11,500 lb											
3.0 m 10'		*3700 kg *8,200 lb	2550 kg 5,600 lb	5200 kg 11,500 lb	3500 kg 7,700 lb	7150 kg 15,800 lb	4900 kg 10,800 lb	*8600 kg *19,000 lb	7100 kg 15,700 lb	*11200 kg *24,700 lb	*11200 kg *24,700 lb	18050 kg *39,800 lb	18050 kg *39,800 lb					
1.5 m 5'		3800 kg 8,400 lb	2450 kg 5,400 lb	5000 kg 11,000 lb	3300 kg 7,300 lb	6800 kg 15,000 lb	4550 kg 10,000 lb	9750 kg 21,500 lb	6500 kg 14,400 lb	*13650 kg *30,100 lb	10100 kg 22,300 lb	*8050 kg *17,800 lb	*8050 kg *17,800 lb					
0 m 0'		3850 kg 8,500 lb	2450 kg 5,400 lb	4850 kg 10,700 lb	3150 kg 6,900 lb	6500 kg 14,300 lb	4300 kg 9,400 lb	9250 kg 20,400 lb	6050 kg 13,300 lb	14700 kg 32,400 lb	9300 kg 20,500 lb	*8100 kg *17,800 lb	*8100 kg *17,800 lb					
-1.5 m -5'		4100 kg 9,000 lb	2600 kg 5,700 lb	4750 kg 10,500 lb	3050 kg 6,700 lb	6300 kg 13,900 lb	4100 kg 9,000 lb	8900 kg 19,700 lb	5750 kg 12,700 lb	14250 kg 31,400 lb	8900 kg 19,600 lb	*10800 kg *23,800 lb	*10800 kg *23,800 lb					
-3.0 m -10'		4550 kg 10,000 lb	2950 kg 6,500 lb	4750 kg 10,400 lb	3050 kg 6,700 lb	6250 kg 13,700 lb	4000 kg 8,900 lb	8800 kg 19,400 lb	5650 kg 12,500 lb	14150 kg 31,200 lb	8800 kg 19,400 lb	*14650 kg *32,300 lb	*14650 kg *32,300 lb					
-4.6 m -15'		5600 kg 12,300 lb	3650 kg 8,000 lb			6300 kg 13,900 lb	4100 kg 9,000 lb	8900 kg 19,600 lb	5750 kg 12,600 lb	*12800 kg *28,200 lb	9000 kg 19,800 lb	*18300 kg *40,300 lb	*18300 kg *40,300 lb					
-6.1 m -20'		*5800 kg *12,800 lb	5250 kg 11,600 lb					*6950 kg *15,300 lb	6000 kg 13,200 lb	*9550 kg *21,100 lb	9350 kg 20,700 lb	*13100 kg *28,800 lb	*13100 kg *28,800 lb					

*Load is limited by hydraulic capacity rather than tipping. Ratings are based on SAE Standard No. J/ISO 10567. Rated loads do not exceed 87% of hydraulic lift capacity or 75% of tipping load.

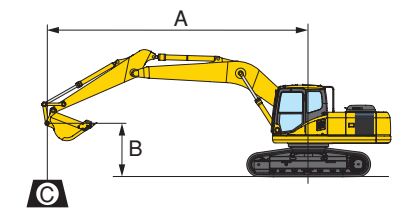

A: Reach from swing center
 B: Bucket hook height
 C: Lifting capacity
 Cf: Rating over front
 Cs: Rating over side
 ●: Rating at maximum reach

PC300LC-7		Arm: 3185 mm 10'5"		Bucket: 1.40 m³ 1.83 yd³ SAE heaped		Shoe: 700 mm 27.6" triple grouser		9.1 m 30'		7.6 m 25'		6.1 m 20'		4.6 m 15'		3.0 m 10'		
B	A	MAX		Cf	Cs	Cf	Cs	Cf	Cs	Cf	Cs	Cf	Cs	Cf	Cs	Cf	Cs	
		Cf	Cs															
7.6 m 25'		*4600 kg *10,100 lb	*4600 kg *10,100 lb			*5950 kg *13,200 lb	5500 kg 12,100 lb											
6.1 m 20'		*4500 kg *9,900 lb	3950 kg 8,800 lb			*6550 kg *14,400 lb	5450 kg 12,000 lb											
4.6 m 15'		*4600 kg *10,200 lb	3450 kg 7,600 lb	6150 kg 13,600 lb	3700 kg 8,200 lb	*7050 kg *15,500 lb	5250 kg 11,600 lb	*8150 kg *18,000 lb	7750 kg 17,100 lb									
3.0 m 10'		*4900 kg *10,800 lb	3100 kg 6,900 lb	6050 kg 13,300 lb	3550 kg 7,900 lb	*7750 kg *17,100 lb	5000 kg 11,000 lb	*9500 kg *20,900 lb	7200 kg 15,800 lb	*12650 kg *27,900 lb	10550 kg 23,300 lb							
1.5 m 5'		5200 kg 11,500 lb	3000 kg 6,600 lb	5900 kg 13,0														

LIFTING CAPACITY WITH LIFTING MODE ON MULTI-FUNCTION COLOR MONITOR

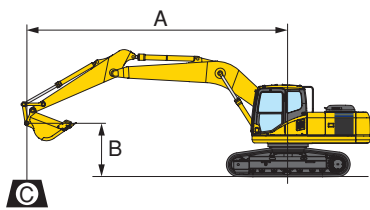

- A: Reach from swing center
- B: Bucket hook height
- C: Lifting capacity
- Cf: Rating over front
- Cs: Rating over side
- ☉: Rating at maximum reach

PC300-7		Arm: 3185 mm 10'5"				Bucket: 1.40 m³ 1.83 yd³ SAE heaped				Shoe: 600 mm 23.6" triple grouser			
B	A	☉ MAX		9.1 m 30'		7.6 m 25'		6.1 m 20'		4.6 m 15'		3.0 m 10'	
		Cf	Cs	Cf	Cs	Cf	Cs	Cf	Cs	Cf	Cs	Cf	Cs
7.6 m 25'		*5000 kg *11,000 lb	4700 kg 10,400 lb			*6500 kg *14,300 lb	5200 kg 11,500 lb						
6.1 m 20'		*4900 kg *10,800 lb	3750 kg 8,300 lb			*7200 kg *15,800 lb	5200 kg 11,400 lb						
4.6 m 15'		4850 kg 10,700 lb	3250 kg 7,100 lb	5200 kg 11,500 lb	3500 kg 7,700 lb	7250 kg 16,000 lb	5000 kg 11,000 lb	*8900 kg *19,600 lb	7400 kg 16,300 lb				
3.0 m 10'		4500 kg 9,900 lb	2950 kg 6,500 lb	5100 kg 11,200 lb	3350 kg 7,100 lb	6900 kg 15,400 lb	4700 kg 10,400 lb	10100 kg 22,300 lb	6850 kg 15,100 lb	*13800 kg *30,400 lb	10550 kg 23,300 lb		
1.5 m 5'		4350 kg 9,600 lb	2800 kg 6,200 lb	4950 kg 10,900 lb	3250 kg 7,100 lb	6700 kg 14,800 lb	4450 kg 9,800 lb	9550 kg 21,100 lb	6350 kg 14,000 lb	15,200 kg 33,600 lb	9750 kg 21,500 lb		
0 m 0'		4450 kg 9,800 lb	2850 kg 6,300 lb	4800 kg 10,600 lb	3100 kg 6,900 lb	6450 kg 14,300 lb	4250 kg 9,400 lb	9150 kg 20,200 lb	6000 kg 13,200 lb	14600 kg 32,200 lb	9200 kg 20,300 lb	*7900 kg *17,400 lb	*7900 kg *17,400 lb
-1.5 m -5'		4750 kg 10,500 lb	3100 kg 6,800 lb	4800 kg 10,600 lb	3100 kg 6,800 lb	6350 kg 14,000 lb	4150 kg 9,100 lb	9000 kg 19,800 lb	5800 kg 12,800 lb	14400 kg 31,700 lb	9050 kg 19,900 lb	*12650 kg *27,900 lb	*12650 kg *27,900 lb
-3.0 m -10'		5500 kg 12,100 lb	3550 kg 7,800 lb			6350 kg 14,000 lb	4150 kg 9,100 lb	8950 kg 19,800 lb	5800 kg 12,800 lb	14450 kg 31,900 lb	9100 kg 20,100 lb	*18500 kg *40,800 lb	*18500 kg *40,800 lb
-4.6 m -15'		7200 kg 15,900 lb	4750 kg 10,400 lb					9150 kg 20,200 lb	6000 kg 13,200 lb	*12450 kg *27,500 lb	9350 kg 20,700 lb	*16800 kg *37,000 lb	*16800 kg *37,000 lb
-6.1 m -20'		*6250 kg *13,800 lb	*6250 kg *13,800 lb							*7550 kg *16,600 lb	*7550 kg *16,600 lb		

PC300-7		Arm: 2200 mm 7'3"				Bucket: 1.40 m³ 1.83 yd³ SAE heaped				Shoe: 600 mm 23.6" triple grouser			
B	A	☉ MAX		7.6 m 25'		6.1 m 20'		4.6 m 15'		3.0 m 10'		1.5 m 5'	
		Cf	Cs	Cf	Cs	Cf	Cs	Cf	Cs	Cf	Cs	Cf	Cs
7.6 m 25'		*8350 kg *18,400 lb	6400 kg 14,100 lb										
6.1 m 20'		7000 kg 15,400 lb	4800 kg 10,600 lb	7200 kg 15,900 lb	4950 kg 10,900 lb	*9000 kg *19,800 lb	7450 kg 16,400 lb						
4.6 m 15'		5950 kg 13,100 lb	4000 kg 8,800 lb	7050 kg 15,500 lb	4800 kg 10,600 lb	*9950 kg *22,000 lb	7050 kg 15,500 lb	*12800 kg *28,300 lb	11200 kg 24,700 lb				
3.0 m 10'		5350 kg 11,800 lb	3550 kg 7,800 lb	6750 kg 14,900 lb	4550 kg 10,000 lb	9700 kg 21,400 lb	6500 kg 14,300 lb	15400 kg 33,900 lb	9900 kg 21,800 lb				
1.5 m 5'		5200 kg 11,500 lb	3400 kg 7,500 lb	6550 kg 14,400 lb	4300 kg 9,500 lb	9050 kg 20,000 lb	5900 kg 13,000 lb	14450 kg 31,900 lb	9100 kg 20,100 lb				
0 m 0'		5350 kg 11,800 lb	3450 kg 7,700 lb	6450 kg 14,000 lb	4150 kg 9,200 lb	8950 kg 19,700 lb	5800 kg 12,800 lb	14200 kg 31,300 lb	8850 kg 19,500 lb				
-1.5 m -5'		5850 kg 12,900 lb	3800 kg 8,400 lb	6350 kg 14,000 lb	4100 kg 9,100 lb	8900 kg 19,600 lb	5750 kg 12,600 lb	14250 kg 31,400 lb	8900 kg 19,600 lb	*15300 kg *33,700 lb	*15300 kg *33,700 lb		
-3.0 m -10'		7100 kg 15,600 lb	4650 kg 10,200 lb			8850 kg 19,500 lb	5700 kg 12,600 lb	*13400 kg *29,500 lb	9100 kg 20,100 lb	*16650 kg *36,700 lb	*16650 kg *36,700 lb		
-4.6 m -15'		*7650 kg *16,900 lb	7000 kg 15,400 lb					*9450 kg *20,800 lb	*9450 kg *20,800 lb				

PC300-7		Arm: 2550 mm 8'4"				Bucket: 1.40 m³ 1.83 yd³ SAE heaped				Shoe: 600 mm 23.6" triple grouser			
B	A	☉ MAX		7.6 m 25'		6.1 m 20'		4.6 m 15'		3.0 m 10'		1.5 m 5'	
		Cf	Cs	Cf	Cs	Cf	Cs	Cf	Cs	Cf	Cs	Cf	Cs
7.6 m 25'		*7050 kg *15,600 lb	5500 kg 12,100 lb										
6.1 m 20'		6250 kg 13,800 lb	4250 kg 9,400 lb	7300 kg *16,100 lb	5050 kg 11,100 lb								
4.6 m 15'		5400 kg 11,900 lb	3600 kg 7,900 lb	7150 kg 15,700 lb	4850 kg 10,700 lb	9600 kg 21,200 lb	7150 kg 15,800 lb						
3.0 m 10'		4950 kg 10,900 lb	3250 kg 7,200 lb	6850 kg 15,100 lb	4600 kg 10,100 lb	9850 kg 21,700 lb	6600 kg 14,600 lb	*15000 kg *33,100 lb	10200 kg 22,500 lb				
1.5 m 5'		4800 kg 10,600 lb	3100 kg 6,900 lb	6600 kg 14,500 lb	4350 kg 9,600 lb	9350 kg 20,600 lb	6150 kg 13,600 lb	14750 kg 32,500 lb	9350 kg 20,600 lb				
0 m 0'		4900 kg 10,800 lb	3200 kg 7,000 lb	6400 kg 14,100 lb	4200 kg 9,200 lb	9050 kg 19,900 lb	5850 kg 12,900 lb	14350 kg 31,600 lb	9000 kg 19,800 lb				
-1.5 m -5'		5350 kg 11,800 lb	3450 kg 7,600 lb	6350 kg 14,000 lb	4100 kg 9,100 lb	8900 kg 19,700 lb	5750 kg 12,700 lb	14300 kg 31,500 lb	8950 kg 19,700 lb	*13300 kg *29,400 lb	*13300 kg *29,400 lb		
-3.0 m -10'		6300 kg 13,900 lb	4100 kg 9,100 lb	6400 kg 14,100 lb	4200 kg 9,300 lb	8800 kg 19,400 lb	5650 kg 12,400 lb	*14150 kg *31,200 lb	9100 kg 20,100 lb	*18500 kg *40,800 lb	*18500 kg *40,800 lb		
-4.6 m -15'		*7350 kg *16,200 lb	5800 kg 12,800 lb			7850 kg *17,300 lb	6100 kg 13,500 lb	*10650 kg *23,500 lb	9500 kg 20,900 lb	*13400 kg *29,500 lb	*13400 kg *29,500 lb		

PC300-7		Arm: 4020 mm 13'2"				Bucket: 1.14 m³ 1.49 yd³ SAE heaped				Shoe: 600 mm 23.6" triple grouser			
B	A	☉ MAX		9.1 m 30'		7.6 m 25'		6.1 m 20'		4.6 m 15'		3.0 m 10'	
		Cf	Cs	Cf	Cs	Cf	Cs	Cf	Cs	Cf	Cs	Cf	Cs
7.6 m 25'		*3900 kg *8,600 lb	3900 kg 8,600 lb										
6.1 m 20'		*3850 kg *8,500 lb	3200 kg 7,000 lb	5550 kg 12,200 lb	3750 kg 8,300 lb								
4.6 m 15'		*3900 kg *8,600 lb	2800 kg 6,100 lb	5400 kg 11,900 lb	3650 kg 8,100 lb	*7050 kg *15,500 lb	5200 kg 11,500 lb						
3.0 m 10'		3950 kg 8,700 lb	2550 kg 5,600 lb	5200 kg 11,500 lb	3500 kg 7,700 lb	7150 kg 15,800 lb	4900 kg 10,800 lb	*9400 kg *20,800 lb	7100 kg 15,700 lb	*12200 kg *26,900 lb	11350 kg 25,000 lb	*19600 kg *43,200 lb	*19600 kg *43,200 lb
1.5 m 5'		3800 kg 8,400 lb	2450 kg 5,400 lb	5000 kg 11,000 lb	3300 kg 7,300 lb	6800 kg 15,000 lb	4550 kg 10,000 lb	*14900 kg *32,800 lb	6500 kg 14,400 lb	9700 kg 21,500 lb	6500 kg 14,400 lb	*8700 kg *19,200 lb	*8700 kg *19,200 lb
0 m 0'		3850 kg 8,500 lb	2450 kg 5,400 lb	4850 kg 10,700 lb	3150 kg 6,900 lb	6500 kg 14,300 lb	4300 kg 9,400 lb	9250 kg 20,400 lb	6050 kg 13,300 lb	14700 kg 32,400 lb	20,500 kg 45,200 lb	*19300 kg *42,800 lb	*8750 kg *19,200 lb
-1.5 m -5'		4100 kg 9,000 lb	2600 kg 5,700 lb	4750 kg 10,500 lb	3050 kg 6,700 lb	6300 kg 13,900 lb	4100 kg 9,000 lb	8900 kg 19,700 lb	5750 kg 12,700 lb	14250 kg 31,400 lb	19,600 kg 43,200 lb	*25,600 kg *56,600 lb	*11650 kg *25,600 lb
-3.0 m -10'		4550 kg 10,100 lb	2950 kg 6,500 lb	4750 kg 10,400 lb	3050 kg 6,700 lb	6250 kg 13,700 lb	4000 kg 8,900 lb	8800 kg 19,400 lb	5650 kg 12,500 lb	14150 kg 31,200 lb	19,400 kg 42,800 lb	*34,800 kg *76,800 lb	*15800 kg *34,800 lb
-4.6 m -15'		5600 kg 12,400 lb	3650 kg 8,100 lb			6300 kg 13,900 lb	4100 kg 9,000 lb	8900 kg 19,600 lb	5750 kg 12,800 lb	*14050 kg *31,000 lb	9000 kg 19,800 lb	*20650 kg *45,200 lb	*19400 kg *42,700 lb
-6.1 m -20'		*6450 kg *14,300 lb	5250 kg 11,500 lb					*7700 kg *17,000 lb	6000 kg 13,300 lb	*10550 kg *23,300 lb	9350 kg 20,700 lb	*14450 kg *31,900 lb	*14450 kg *31,900 lb

LIFTING CAPACITY WITH LIFTING MODE ON MULTI-FUNCTION COLOR MONITOR

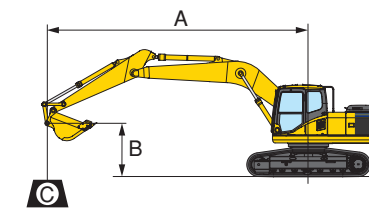

- A: Reach from swing center
- B: Bucket hook height
- C: Lifting capacity
- Cf: Rating over front
- Cs: Rating over side
- ☉: Rating at maximum reach

PC300LC-7		Arm: 3185 mm 10'5"				Bucket: 1.40 m³ 1.83 yd³ SAE heaped				Shoe: 700 mm 27.6" triple grouser			
B	A	☉ MAX		9.1 m 30'		7.6 m 25'		6.1 m 20'		4.6 m 15'		3.0 m 10'	
		Cf	Cs	Cf	Cs	Cf	Cs	Cf	Cs	Cf	Cs	Cf	Cs
7.6 m 25'		*5000 kg *11,000 lb	4950 kg 10,900 lb			*6500 kg *14,300 lb	5500 kg 12,100 lb						
6.1 m 20'		*4900 kg *10,800 lb	3950 kg 8,800 lb			*7200 kg *15,800 lb	5450 kg 12,000 lb						
4.6 m 15'		*5050 kg *11,100 lb	3450 kg 7,600 lb	6150 kg 13,600 lb	3700 kg 8,200 lb	*7750 kg *17,000 lb	5250 kg 11,600 lb	*8900 kg *19,600 lb	7750 kg 17,100 lb				
3.0 m 10'		*5350 kg *11,800 lb	3100 kg 6,900 lb	6350 kg 13,300 lb	3550 kg 7,900 lb	*10350 kg *22,900 lb	5000 kg 11,000 lb	*10350 kg *22,900 lb	7200 kg 15,800 lb	*13800 kg *30,400 lb	11050 kg 24,400 lb		
1.5 m 5'		5200 kg 11,500 lb	3000 kg 6,600 lb	5900 kg 13,000 lb	3350 kg 7,400 lb	7700 kg 17,000 lb	4700 kg 10,400 lb	11350 kg 25,100 lb	6700 kg 14,800 lb	*17000 kg *37,500 lb	9700 kg 21,400 lb	*7900 kg *17,400 lb	*7900 kg *17,400 lb
0 m 0'		5300 kg 11,700 lb	3050 kg 6,700 lb	5750 kg 12,700 lb	3350 kg 7,400 lb	7700 kg 17,000 lb	4500 kg 9,900 lb	10950 kg 24,200 lb	6350 kg 14,000 lb	*17000 kg *37,500 lb	9700 kg 21,400 lb	*7900 kg *17,400 lb	*7900 kg *17,400 lb
-1.5 m -5'		5700 kg 12,600 lb	3300 kg 7,300 lb	5700 kg 12,600 lb	3300 kg 7,300 lb	7600 kg 16,700 lb	4400 kg 9,700 lb	10750 kg 23,700 lb	6150 kg 13,600 lb	*16650 kg *36,700 lb	9550 kg 21,000 lb	*12650 kg *27,900 lb	*12650 kg *27,900 lb
-3.0 m -10'		6550 kg 14,500 lb	3800 kg 8,400 lb			7600 kg 16,700 lb	4400 kg 9,700 lb	10750 kg 23,700 lb	6150 kg 13,600 lb	*15300 kg *33,700 lb	9600 kg 21,200 lb	*18500 kg *40,800 lb	*18500 kg *40,800 lb
-4.6 m -15'		*7400 kg *16,300 lb	5000 kg 11,100 lb					*9400 kg *20,700 lb	6300 kg 13,900 lb	*12450 kg *27,500 lb	9850 kg 21,800 lb	*16800 kg *37,000 lb	*16800 kg *37,000 lb
-6.1 m -20'		*6250 kg *13,800 lb	*6250 kg *13,800 lb							*7550 kg *16,600 lb	*7550 kg *16,600 lb		

PC300LC-7		Arm: 2200 mm 7'3"				Bucket: 1.40 m³ 1.83 yd³ SAE heaped				Shoe: 700 mm 27.6" triple grouser			
B	A	☉ MAX		7.6 m 25'		6.1 m 20'							



STANDARD EQUIPMENT

- Alternator, 35 Ampere, 24V
- Auto-Decel
- Automatic engine warm-up system
- Batteries, **126 Ah**/2 x 12V
- Boom holding valve
- Cab, capable FOG with optional bolt-on top guard
- Corrosion resistor
- Counterweight
- Dry type air cleaner, double element
- Electric horn
- Engine, Komatsu SAA6D114E
- Engine overheat prevention system
- Fan guard structure
- Hydraulic track adjusters (each side)
- Monitor panel, 7-segment
- Power maximizing system
- PPC hydraulic control system
- Radiator & oil cooler dust proof net
- Rear view mirror, R.H.
- Starting motor, **7.5 kW/24 v x 1**
- Suction fan
- Track guiding guard, center section
- Track roller
 - PC300-7, 7 each side
 - PC300LC-7, 8 each side
- Track shoe
 - PC300-7, **600 mm** 23.6" triple grouser
 - PC300LC-7, **700 mm** 27.6" triple grouser
- Two settings for boom
- Working light, 2 (boom and RH)
- Working mode selection system



OPTIONAL EQUIPMENT

- Air conditioner with defroster
- Alternator, 60 ampere, 24 V
- Arms
 - 2220 mm** 7'3" arm assembly
 - 2550 mm** 8'4" arm assembly
 - 3185 mm** 10'5" arm assembly
 - 4020 mm** 13'2" arm assembly
- Batteries, **140 Ah**/2 x 12 V
- Bolt-on top guard, (Operator Protective Guards level 2 (FOG))
- Boom, **6470 mm** 21'3"
- Cab accessories
 - Rain visor
 - Sun visor
- Cab front guard
 - Full height guard
 - Half height guard
- Heater with defroster
- Long lubricating intervals for Implement bushing
- Multi-Function Color Monitor
- Rearview mirror (LH)
- Seat belt, retractable
- Seat, suspension
- Service valve
- Shoes, triple grouser shoes
 - PC300-7
 - 700 mm** 27.6", **800 mm** 31.5",
 - PC300LC-7
 - 600 mm** 23.6", **800 mm** 31.5",
- Track roller guards (full length)
- Track frame undercover
- Travel alarm
- Working lights (2 on cab)



SPECIAL PURPOSE BUCKET

- **Trapezoidal bucket** is ideal for digging ditches and for drainage works
 - Capacity
 - SAE heaped **1.1 m³** 1.44 yd³
 - CECE heaped **0.9 m³** 1.18 yd³
- **Slope finishing bucket** for scraping slopes of banks
 - Capacity
 - SAE heaped **0.41 m³** 0.54 yd³
 - CECE heaped **0.35 m³** 0.46 yd³
 - Width **2200 mm** 86.6"
- **Ripper bucket** for hard and rock ground
 - Capacity
 - SAE heaped **0.9 m³** 1.18 yd³
 - CECE heaped **0.8 m³** 1.05 yd³
 - Width **1200 mm** 47.2"
 - **Single-shank ripper** and **three-shank ripper** are recommended for rock-digging and crushing, hard soil digging, pavement removal works, etc.

KOMATSU®