

KOMATSU[®]

HD325-8

Tier 4 Final Engine

OFF-HIGHWAY TRUCK

HD325



Photos may include optional equipment.

HORSEPOWER

Gross: 518 HP 386 kW
Net: 514 HP 383 kW

MAX PAYLOAD

40.3 US tons 36.5 metric tons

BODY CAPACITY

Heaped (SAE 2:1): 31.4 yd³ 24.0 m³

WALK-AROUND

PRODUCTIVITY FEATURES

- High performance Komatsu SAA6D140E-7 engine with increased horsepower (Net **514 HP/383 kW**)
- Variable Geometry Turbocharger (VGT) is hydraulically actuated to provide optimum air flow under all speed and load conditions
- Komatsu Diesel Particulate Filter (KDPF) and Selective Catalytic Reduction (SCR) system reduce particulate matter and NOx while providing automatic regeneration that does not interfere with daily operation
- 7-speed, fully automatic K-ATOMiCS transmission with skip shift function
- Automatic Retard Speed Control (ARSC)
- Rear wet, multiple-disc brakes provide high retarding capability (**924 HP/689 kW**)
- Tight turning radius: 7.2 m **23' 7"**
- Integrated Payload Meter (PLM)



Photos may include optional equipment.

HORSEPOWER

Gross: 518 HP 386 kW
Net: 514 HP 383 kW

MAX PAYLOAD

40.3 US tons 36.5 metric tons

BODY CAPACITY

Heaped (SAE 2:1): 31.4 yd³ 24.0 m³

HD325-8



PRODUCTIVITY AND FUEL ECONOMY

Komatsu Traction Control System (KTCS) monitors for wheel spin and automatically applies independent brake assemblies for optimum traction in all ground conditions to improve productivity.

Selectable working modes for Economy and Power allow machine performance to be optimized based on demand and operating conditions.

OPERATOR ENVIRONMENT

- Air suspension, heated, ventilated seat
- Angled front stairways with handrails for easy access
- Automatic climate control system
- Ergonomically designed, spacious cab with excellent visibility
- Heated rearview mirrors
- Hydro-pneumatic suspension
- KOMTRAX® allows remote access to maintenance and performance information
- Machine monitor with high resolution, seven-inch color Liquid Crystal Display (LCD) unit
- Rearview monitor system
- Two 12 volt power outlets
- Viscous cab mounts for a quiet (78 dBA), comfortable ride

ECOLOGY AND FUEL EFFICIENCY

- Energy saving operation thanks to ecology guidance
- Fuel consumption reduced up to nine percent compared to the HD325-7
- Komatsu auto idle shutdown helps reduce idle time and operating costs
- Komatsu SAA6D140E-7 engine is EPA Tier 4 Final emissions certified

RELIABILITY FEATURES

- High-rigidity frame
- Komatsu designed and manufactured components
- Robust dump body design
- Secondary hydraulic brakes
- Supplementary steering, automatic

MAINTENANCE FEATURES

- Advanced monitoring system with onboard diagnostics, no laptop computer required
- Centralized, ground level, access to filters and greasing points
- Fast fuel fill coupler
- Hydraulically operated, reversible cooling fan
- Komatsu CARE®
- Modular radiator core system



ECOLOGY & ECONOMY FEATURES

NEW ENGINE TECHNOLOGIES

Komatsu's New Emission Regulation-compliant Engine

Komatsu provides a powerful and efficient EPA Tier 4 Final certified engine, with the latest emission control technologies and fuel saving features.

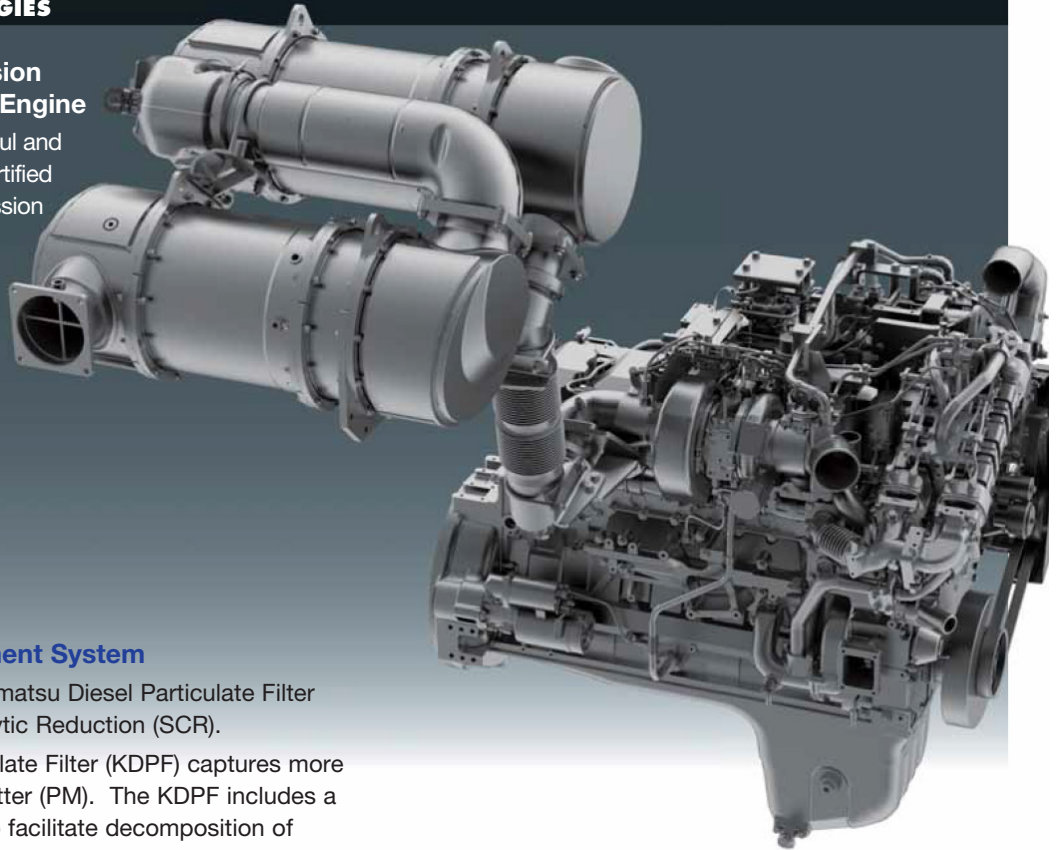

Heavy-Duty Aftertreatment System

The system combines a Komatsu Diesel Particulate Filter (KDPF) and Selective Catalytic Reduction (SCR).

The Komatsu Diesel Particulate Filter (KDPF) captures more than 90% of Particulate Matter (PM). The KDPF includes a special oxidation catalyst to facilitate decomposition of most PM without operator action and no need to interrupt normal operation.

The SCR NOx reduction system injects the correct amount of Diesel Exhaust Fluid (DEF) at the proper rate, thereby decomposing NOx into non-toxic water vapor (H₂O) and nitrogen gas (N₂).

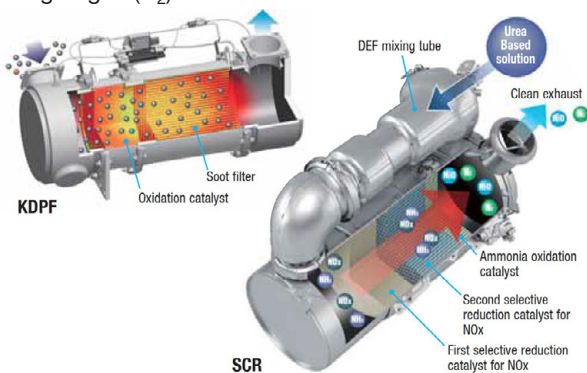

Variable Geometry Turbocharger (VGT) System

The VGT system uses proven, Komatsu-designed hydraulic technology for variable control of airflow, and supplies optimal air, based on load conditions.

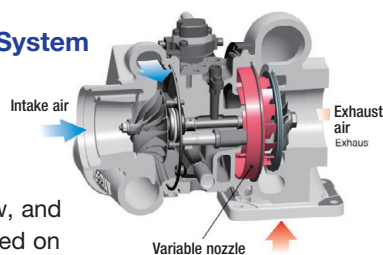

Heavy-Duty Cooled Exhaust Gas Recirculation (EGR) System

The system recirculates a portion of exhaust gas into the air intake and lowers combustion temperatures. The system dramatically reduces NOx and lowers fuel consumption.

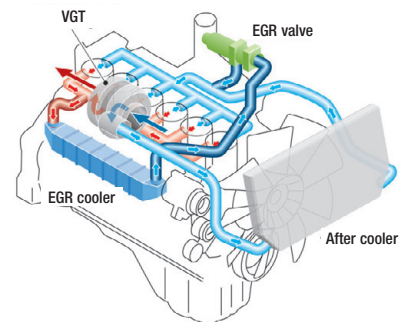

High Pressure Common Rail (HPCR) Fuel Injection System

The system is designed to achieve an optimal injection of high-pressure fuel via computerized control, providing near-complete combustion to reduce PM emissions.

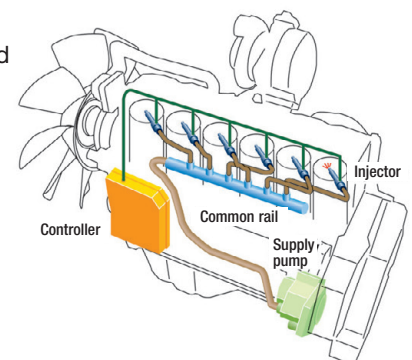

Energy Saving Operation

To support optimum operation, an easy-to-read ecology gauge is included at the LCD unit of the machine monitor. The ecology gauge indicates a momentary fuel consumption rate during operation. Operating the vehicle with the gauge in the green zone ensures the most energy efficient operation.

The monitor provides ecology guidance to the operator to help promote energy-saving operation.

For example, if the operator stops the machine for a long time with the engine idling, the monitor will display the message "Avoid long time engine idling".

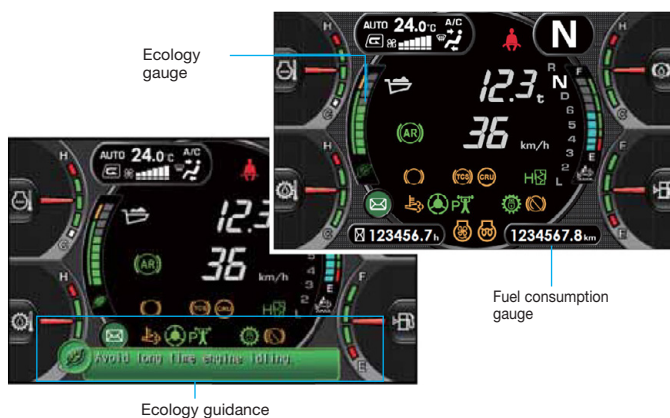

Low Fuel Consumption

The latest Komatsu "on demand" energy saving technologies achieve lower fuel consumption, while keeping high productivity.

- New variable displacement piston pumps for the steering & hoist circuits
- Improved transmission control hydraulic pressure management

Auto Idle Shutdown

When the engine is idling for a certain time (settings from 5 to 60 minutes), the engine automatically stops to reduce unnecessary fuel consumption and exhaust emissions.

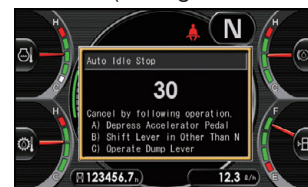

PERFORMANCE FEATURES

High Performance Komatsu SAA6D140E-7 Engine

The powerful and fuel-efficient Komatsu SAA6D140E-7 engine delivers **514 HP** (383 kW) (net) at 2000 rpm.



Long Wheelbase and Wide Tread

With an extra-long wheelbase, a wide tread and an exceptionally low center of gravity, the HD325-8 hauls loads at higher speed for greater productivity and delivers superior driving comfort over rough terrain.

Small Turning Radius

The McPherson-strut-type front suspension has a special A-arm between each wheel and the main frame. The wider space created between the front wheels and the main frame increases the turning angle of the wheels. The larger turning angle correlates to a smaller turning radius.

Minimum Turning Radius:
23'7" 7.2 m

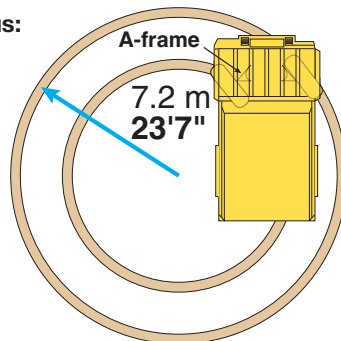

Fully Hydraulic Controlled Rear Wet Multiple-Disc Brakes and Retarder

Rear wet multiple-disc brakes ensure highly reliable and stable brake performance. The large-capacity, continuously-oil-cooled, multiple-disc brakes also function as a highly responsive retarder, which gives the operator greater confidence at higher downhill speeds.

Retarder Absorbing Capacity:
924 HP 689 kW

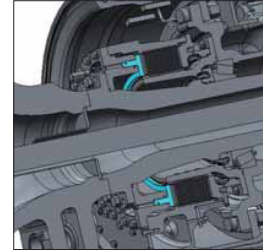

Komatsu Advanced Transmission with Optimum Modulation Control System (K-ATOMiCS) with Skip Shift Function

Fully automatic control selects the optimum gear according to vehicle and engine speed. The shift point automatically changes depending on the acceleration of the vehicle, reducing fuel consumption.



Skip shift function:

Automatically selects a gear position depending on the grade, eliminating the need to shift down through each gear when travelling uphill. It also reduces the number of downshifts, makes the driving smoother, improves the operator's comfort and reduces material spillage.

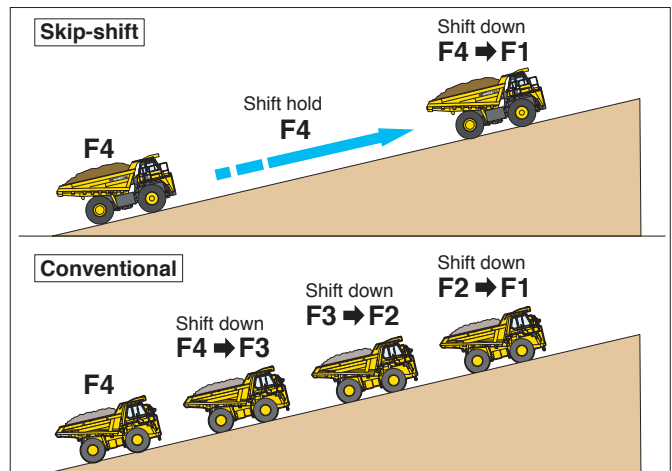

HD325-8

Automatic Retard Speed Control (ARSC)

ARSC allows the operator to simply set the downhill travel speed at a constant speed, allowing the operator to concentrate on steering. The speed can be set at increments of **0.6 mph** 1km/h per click (+/- **3.1 mph** 5 km/h of maximum speed adjustment) to match the optimum speed for the slope. The retarder cooling oil is continuously monitored and the travel speed is automatically lowered if the oil temperature increases to a set limit.



Selectable Working Modes

The operator can choose between two working modes, Economy or Power, depending on their work demand and conditions.



Power mode

PX Appropriate for higher production jobs and uphill hauling applications. Power mode utilizes maximum engine output and raises the upshift and downshift engine speeds during operation.

Economy mode

EX Appropriate for lighter work on flat ground. Economy mode lowers engine output, along with lowering the upshift and downshift engine speeds during operation.

Automatic Idling Setting System

This system facilitates quick engine warm-up and operator cab cooling/warming. When turning the system ON, engine idle speed is kept at 1100 rpm, but is lowered to 750 rpm when the coolant temperature rises. Speed automatically returns to 1100 rpm when the coolant temperature drops.



Komatsu Traction Control System (KTCS)

New KTCS ensures optimum traction in soft or wet road conditions. The system monitors for wheel slippage at the rear axle, and an acceleration sensor allows determination of a high speed turn versus slippage.

If slippage is detected, the brakes are applied independently to each wheel set for optimum traction. This function occurs automatically without operator input and steering performance is not compromised, as with a differential lock system.

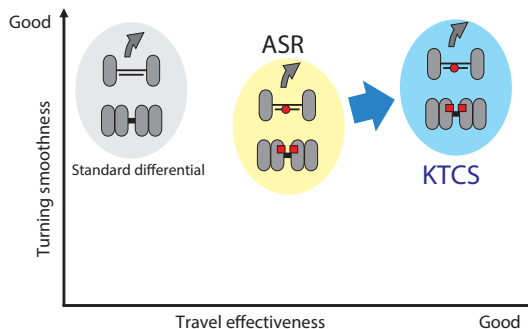
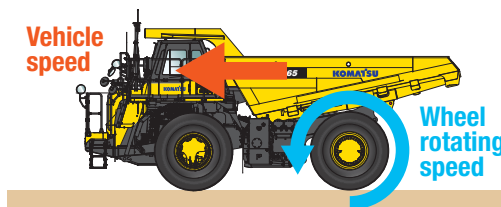

OPERATOR COMFORT & ENVIRONMENT



HD325-8

Ergonomically Designed Cab

The ergonomically designed operator's compartment provides the operator a convenient control layout and comfortable environment for more confident operation and greater productivity.



Automatic Climate Control System

The automatic climate control system allows the operator to easily set and maintain a desired cab ambient temperature. Excellent heating/cooling capacity and air flow keep the cab environment comfortable throughout the year.



Radio with AUX Terminal

By connecting an auxiliary sound device to the input jack, the operator can listen to the sound through the speakers in the cab.



Storage Spaces

Generous storage spaces are provided inside the cab. **Glove box, lunch box tray, hot or cool box, and cup holder**



Lunch box tray



Hot or cool box, cup holder

Air Suspension Seat

The heated and ventilated, air suspension, fabric-covered seat is adjustable to the operator's weight, and is provided as standard. The air suspension seat dampens vibrations transmitted from the machine to reduce operator fatigue. A three-point operator seat belt is standard.

Foldable Trainer Seat

The foldable trainer seat includes a two-point, retractable seat belt. Seat comfort has been significantly improved.



Tilt-Away Steering Column

The tilt steering column and telescopic steering wheel allow the operator to set the steering wheel to the desired position. The tilt mechanism incorporates a spring-assist for easy adjustment.



Low Noise Design

The spacious cab is mounted with large-capacity viscous mounts. The low-noise engine, hydraulically-driven fan and cab sealing provide a quiet, low-vibration and comfortable operating environment.

Noise Level at Operator's Ear:
78 dB(A) (ISO 6396)

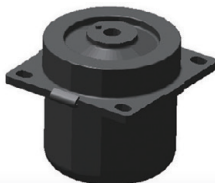

12V DC Outlet

Two 12V DC outlets are standard in the operator's cab. A 12V cigarette lighter is located on the front side of the center console, and an additional 12V outlet is located on the rear cover, behind the operator seat.



Cigarette lighter (12V DC)
AUX terminal
12V DC electrical outlet



Electronic Hoist Control

The hoist control lever has a short throw and can be operated with light effort. A "kick-out function" eliminates the need to hold the lever in the raise position. Body seating shock is significantly reduced by the use of a positioning sensor that reduces the lowering speed just before the body seats on the mainframe.



Hydropneumatic Rear Suspension

The hydropneumatic suspension provides a smoother ride over rough terrain to maximize production and operator comfort.

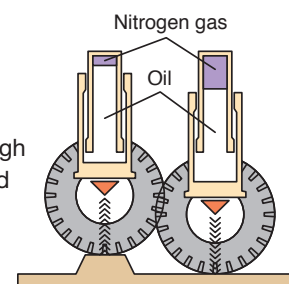

McPherson Strut Type Front Suspension

McPherson-strut-type independent suspension is used on the front wheels. The linkage arrangement is a low friction design that allows the front wheels to follow uneven road surface smoothly for a comfortable ride.

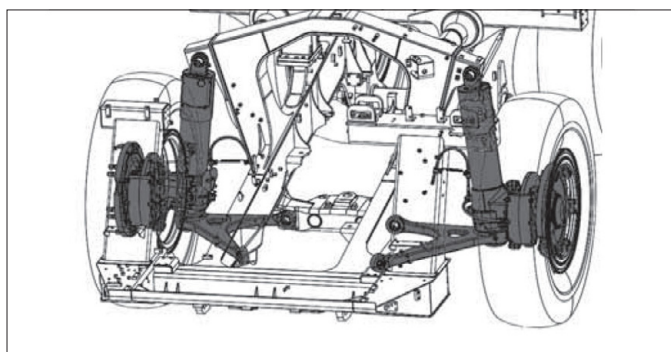
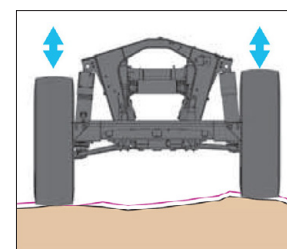

GENERAL FEATURES



HD325-8

Rearview Monitor System

The operator can view behind the vehicle on the full color monitor, located on the right side of the dashboard. This monitor can be always ON, or only when the shift lever is in the reverse position. Visual distance guidelines can be added for the operator's convenience.



Rearview monitor



Rearview camera

Convenient Access

Inclined stairs with handrails provide easy access to the cab and service deck.

Dimpled Slip-Resistant Plates

Stairways and walkways are made with dimpled slip-resistant plates for better traction.

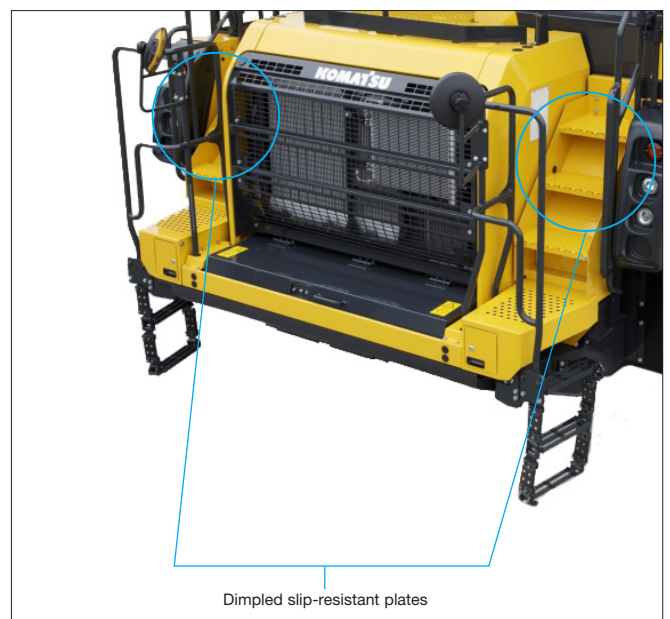

Dimpled slip-resistant plates

Built-In ROPS/FOPS Cab

The operator cab structure conforms to the ISO 3471 ROPS standard, and ISO 3449 FOPS Level II standard.



Secondary Engine Shutdown Switch

A secondary engine shutdown switch is located in the cab for emergency use.



LED Rear Combination Lamps

LED lamps are standard for the rear combination lamps. The LED lamps feature long service life and excellent visibility.



Round Halogen Head Lamps

Round-shaped halogen lamps are used for the head lamps to provide increased lighting, compared to the previous truck model.

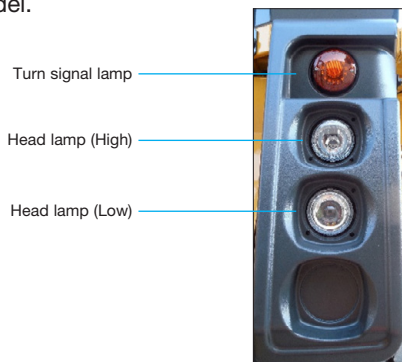

Secondary Steering

The secondary steering system is automatically activated if the steering circuit hydraulic pressure lowers due to a hydraulic system failure. This can also be activated manually by the secondary steering switch in the cab. The pilot lamp on the LCD monitor tells the operator that the system is operable when turning the key switch on.



Secondary Brake

Secondary brakes are a standard feature. When the secondary brake pedal is depressed, a redundant hydraulic circuit applies the front brakes and the rear parking brakes.



Protection Functions Supported by Electronic Control

Item	Function
Downshift inhibitor	Even if the driver downshifts accidentally, the transmission gear is maintained until the vehicle speed becomes appropriate to the selected gear for preventing over-runs.
Over-run inhibitor	When descending grades, if the vehicle's speed surpasses the maximum speed for the current gear, the rear brakes are automatically activated, preventing over-runs.
Reverse inhibitor	The vehicle is prevented from shifting to reverse gear when operating the body.
Forward/Reverse shift inhibitor	This device makes it impossible to select a change in travel direction when the vehicle's speed exceeds 4 km/h.
Anti-hunting system	When running near the shift point, smooth travel is maintained by preventing unnecessary shifts up or down.
Neutral start interlock	The engine is prevented from starting when the shift lever is not in neutral.
Neutral coast inhibitor	It prevents the gear position from shifting to neutral while traveling over a certain speed, even if the shift lever is moved to the neutral position.

TECHNOLOGY

MACHINE MONITOR WITH LARGE HIGH RESOLUTION LCD UNIT

Machine Monitor

The machine monitor displays machine information and provides access to machine settings.

Switch panel

The switch panel is used to select various LCD screens and the air conditioner control screen. By using the switch panel, you can display user menus on the LCD screen and access machine settings and lighting conditions. A keypad provides simple and easy navigation to machine operation information.

Large Multi-Lingual LCD Monitor

A large, user-friendly color monitor provides excellent screen visibility via a TFT liquid crystal display that is easily read at various angles and lighting conditions. A keypad provides simple and easy navigation to machine operation information.

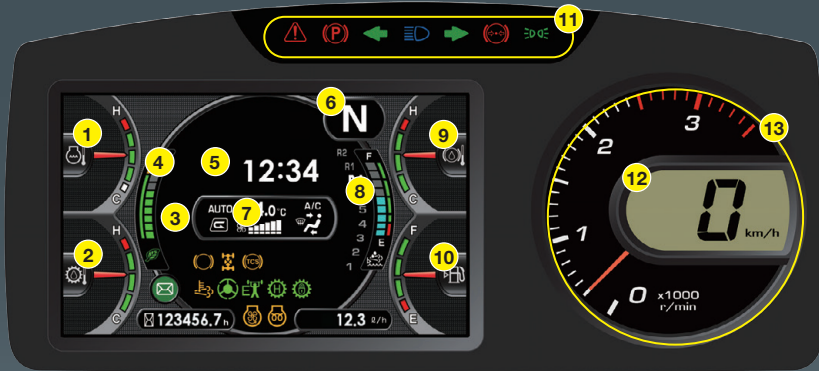

Machine Monitor

- 1 Engine coolant temperature gauge
- 2 Torque converter oil temperature gauge
- 3 A/C display
- 4 Ecology gauge
- 5 Payload / clock
- 6 Shift indicator
- 7 ARSC set travel speed
- 8 DEF level gauge
- 9 Retarder oil temperature gauge
- 10 Fuel gauge
- 11 LED indicator
- 12 Speedometer
- 13 Engine tachometer

Switch Panel

- 1 Air conditioner (A/C) switches / Numeric keypad
- 2 Function switches

Maintenance Reminders

When the time remaining to the next scheduled maintenance is less than 30 hours*, the maintenance time monitor appears.

* The time can be set between 10 and 200 hours.



Maintenance screen

Troubleshooting Function

Various meters, gauges, and warning functions are centrally arranged on the LCD unit. This unit facilitates the start-up inspection and promptly warns the operator with a lamp and a buzzer if any abnormality occurs. Each abnormal condition is indicated in one of four recommended action levels.

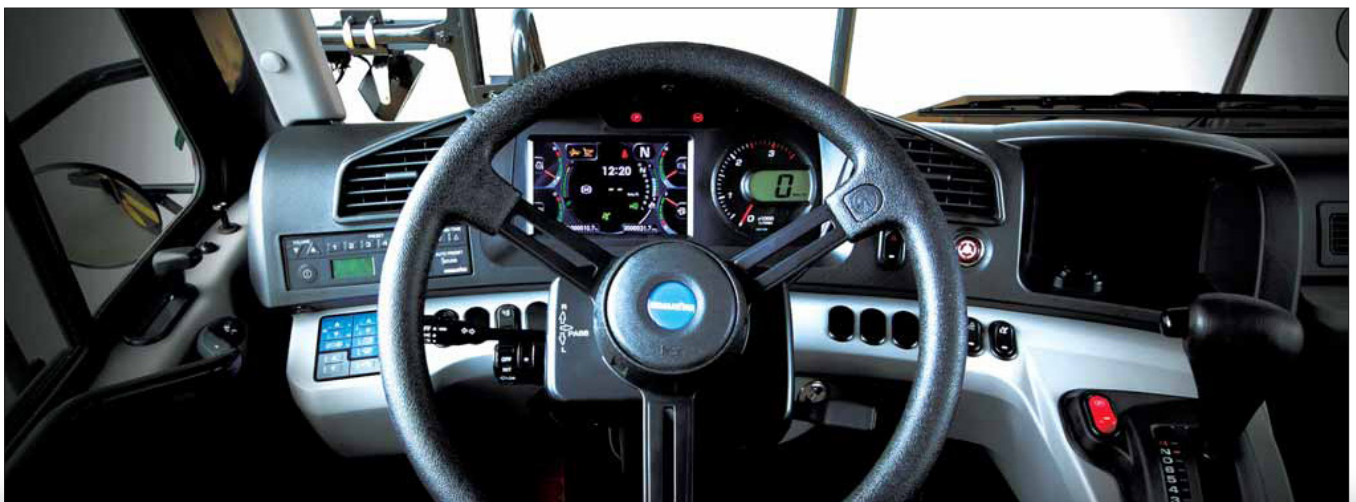

HD325-8

Visual User Menu

Pressing the menu switch on the switch panel displays the user menu screen. The menus are grouped by their functions. Easy-to-understand icons enable intuitive use.

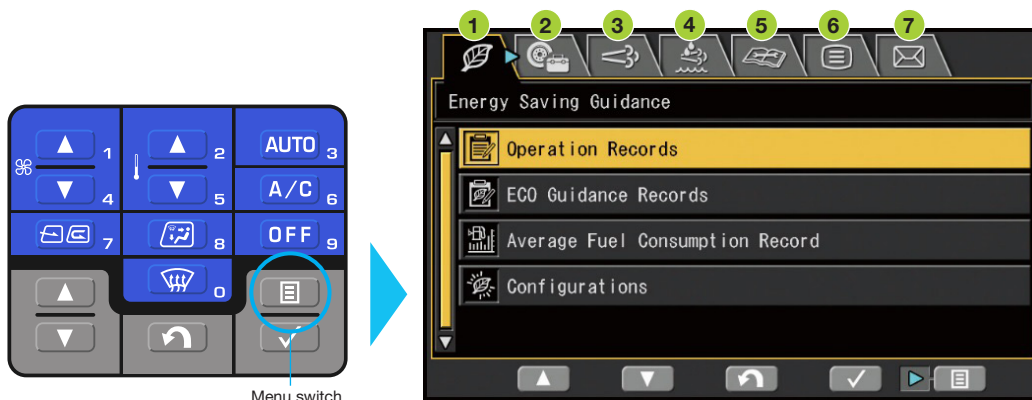

1 Energy saving guidance

- Operation records
- Ecology guidance records
- Average fuel consumption record
- Configurations

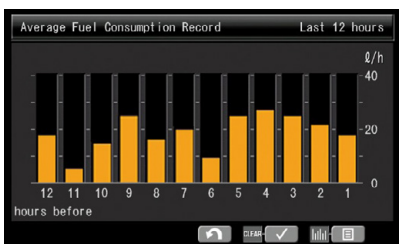

2 Machine setting / information

- Radiator fan reverse mode
- KTCS setting etc.

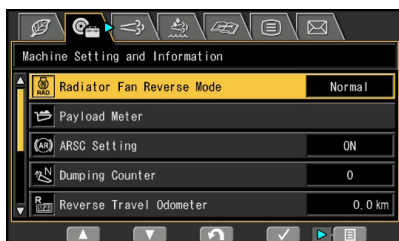

3 Aftertreatment regeneration

- Setting regeneration disable
- Operation of manual stationary regeneration

4 SCR system information

5 Maintenance

- Check and reset of various maintenance intervals

Maintenance	Interval	Remain
Air Cleaner Cleaning or Change	—	—
Engine Oil Change	500 h	500 h
Engine Oil Filter Change	500 h	500 h
Fuel Prefilter Change	500 h	500 h
T/M Oil Filter Change	500 h	500 h

6 Monitor setting

- Language setting
- Measurement unit setting
- Screen brightness adjustment etc.
- Rearview monitor setting

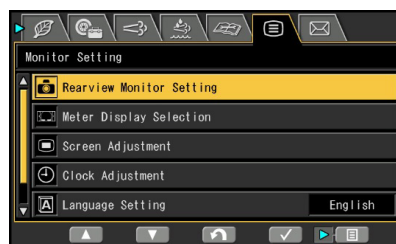

7 Mail check

RELIABILITY FEATURES

High Rigidity Frame

Cast steel components are used in critical areas of the main frame where loads and shocks are most concentrated.

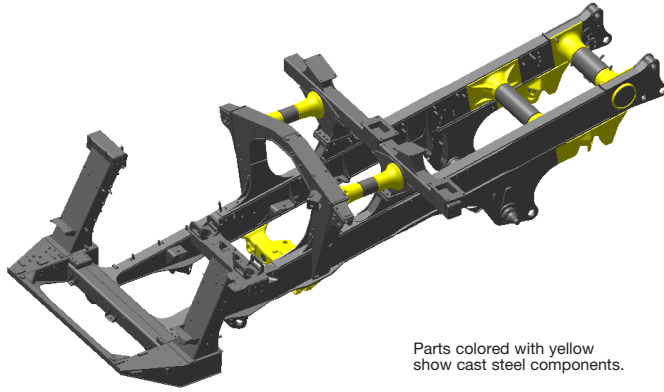

Parts colored with yellow show cast steel components.

Integrated Payload Meter (PLM)

The PLM tool is used to analyze production volume by measuring payloads and working conditions over time. Real time loaded weight is shown on the payload display and by the external display lamps.



External display lamp

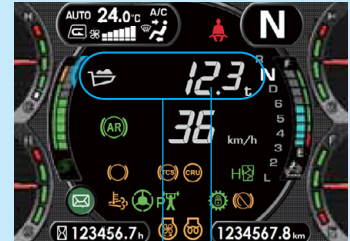

Payload display Loaded weight

Robust Dump Body Design

Dump bodies are made of high-tensile-strength steel for excellent rigidity and low maintenance cost. Major portions of the interior surface are made of abrasion resistant, HB400 steel for excellent wear characteristics. The V-bottom design contributes to the structural strength and enhanced machine stability by centering the load at a lower center of balance. The side and thick bottom plates of the dump body are reinforced with lateral and longitudinal bolsters.



MAINTENANCE FEATURES

Centralized Arrangement of Filters

The filters are conveniently grouped for easy service.



Electric Circuit Breaker

Circuit breakers are used for important electric circuits that need to be restored quickly if a problem occurs in the electrical system.



Centralized Greasing Points

Greasing points are centralized at four locations. Each of these locations is accessible from ground level.



Electric Priming Pump

An electric fuel priming pump is standard.



Easy Access DEF Tank

Located to the rear of the fuel tank and easy to access.



Ground Accessible Battery Compartment

The battery compartment is located at ground level to facilitate daily checks and battery replacement.

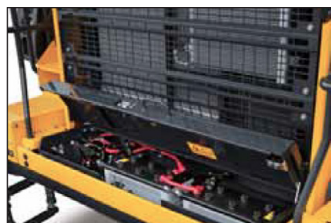

Battery Disconnect Switch

For service work, a battery disconnect switch is located on the right side of the battery compartment and is accessible from ground level.



Extended Oil Change Intervals

Longer oil change intervals minimize operating cost.

- Engine oil-500 hours
- Hydraulic oil-4000 hours
- Transmission oil-1000 hours

Reversible Fan

The radiator fan is hydraulically driven and reversible. The fan reverse mode can be controlled from the monitor.

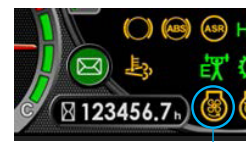
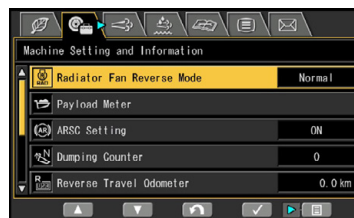

Fan reverse indicator

Modular Radiator Core System

The radiator assembly consists of three cores. Each core can be independently replaced without removing the entire assembly.

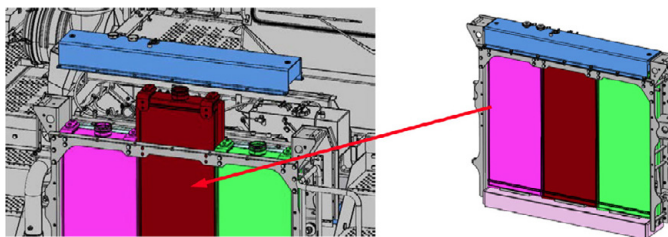

Maintenance Information

DEF Level and Refill Timing

The DEF level gauge is displayed continuously on the right side of the monitor screen. In addition, when the refill timing* is reached, the low DEF level guidance appears as a pop up display to inform the operator in real time.

* The Tier 4 Final emission requirements for off-road engines stipulates that the engine output has to be limited when DEF level becomes very low.



DEF level gauge

KOMATSU PARTS & SERVICE SUPPORT



HD325-8

KOMATSU CARE

Program Includes:

The HD325-8 comes standard with complimentary factory scheduled maintenance for the first 3 Years or 2,000 Hours, whichever comes first.*

Planned Maintenance Intervals at:

500/1000/1500/2000 hour intervals. (250 hr. initial interval for some products) Complimentary Maintenance Interval includes: Replacement of Oils & Fluid Filters with genuine Komatsu Parts, 50-Point inspection, Komatsu Oil & Wear Analysis Sampling (KOWA) / Travel & Mileage (distance set by distributor; additional charges may apply)

Benefits of Using Komatsu CARE

- Assurance of Proper Maintenance with OEM Parts & Service
- Increased Uptime & Efficiency
- Factory Certified Technicians Performing Work
- Cost of Ownership Savings
- Transferable Upon Resale

Complimentary KDPF Exchanges

The HD325-8 comes standard with 2 Complimentary KDPF Exchange units for the first 5 Years or 9000 hours whichever comes first. The suggested KDPF Exchange unit service intervals are 4500 hours & 9000 hours. End user must have authorized Komatsu distributor perform the removal & installation of the KDPF.

PM Interval	500	1000	1500	2000
CLEAN AIR CLEANER ELEMENT	✓	✓	✓	✓
DRAIN SEDIMENT FROM FUEL TANK	✓	✓	✓	✓
COMPLETE 50 POINT INSPECTION FORM; LEAVE PINK COPY WITH CUSTOMER OR IN CAB	✓	✓	✓	✓
RESET MONITOR PANEL MAINTENANCE COUNTER FOR APPROPRIATE ITEMS	✓	✓	✓	✓
PERFORM KOWA SAMPLING (6 samples) – Engine, Transmission & Brake, Steering & Boost, Rear L & R Final Drive, Rear Differential	✓	✓	✓	✓
CHANGE ENGINE OIL	✓	✓	✓	✓
REPLACE ENGINE OIL FILTER CARTRIDGE	✓	✓	✓	✓
REPLACE FUEL PRE-FILTER CARTRIDGE	✓	✓	✓	✓
REPLACE FUEL MAIN FILTER		✓		✓
REPLACE DEF TANK BREATHER		✓		✓
REPLACE KCCV FILTER ELEMENT				✓
REPLACE DEF PUMP FILTER				✓
FACTORY TRAINED TECHNICIAN LABOR	✓	✓	✓	✓
2 KDPF Exchanges at 4,500 Hrs and 9,000 Hrs				

* Certain exclusions and limitations apply. Refer to the customer certificate for complete program details and eligibility. Komatsu® and Komatsu Care® are registered trademarks of Komatsu Ltd. Copyright 2018 Komatsu America Corp.

Komatsu CARE® – Extended Coverage

- Extended Coverage can provide peace of mind by protecting customers from unplanned expenses that effect cash flow
- Purchasing extended coverage locks-in the cost of covered parts and labor for the coverage period and helps turn these into fixed costs



Komatsu Parts Support

- 24/7/365 to fulfill your parts needs
- 9 parts Distribution Centers strategically located across the U.S. and Canada
- Distributor network of more than 300 locations across U.S. and Canada to serve you
- Online part ordering through Komatsu eParts
- Remanufactured components with same-as-new warranties at a significant cost reduction



Komatsu Oil and Wear Analysis (KOWA)

- KOWA detects fuel dilution, coolant leaks, and measures wear metals
- Proactively maintain your equipment
- Maximize availability and performance
- Can identify potential problems before they lead to major repairs
- Reduce life cycle cost by extending component life

KOMTRAX EQUIPMENT MONITORING

GET THE WHOLE STORY WITH **KOMTRAX**

✓ WHAT

- KOMTRAX is Komatsu's remote equipment monitoring and management system
- KOMTRAX **continuously monitors and records** machine health and operational data
- Information such as fuel consumption, utilization, and a detailed history **lowering owning and operating cost**

✓ WHEN

- Know when your machines are **running or idling** and make decisions that will improve your fleet utilization
- Detailed movement records ensure you know when and where your equipment is moved
- Up to date records allow you to **know when maintenance is due** and help you plan for future maintenance needs

✓ WHERE

- KOMTRAX data **can be accessed virtually anywhere** through your computer, the web or your smart phone
- Automatic alerts keep fleet managers up to date on the latest machine notifications

✓ WHO

- KOMTRAX is **standard** equipment on all Komatsu construction products

✓ WHY

- Knowledge is power - **make informed decisions** to manage your fleet better
- Knowing your idle time and fuel consumption will help maximize your machine efficiency
- **Take control of your equipment** - any time, anywhere

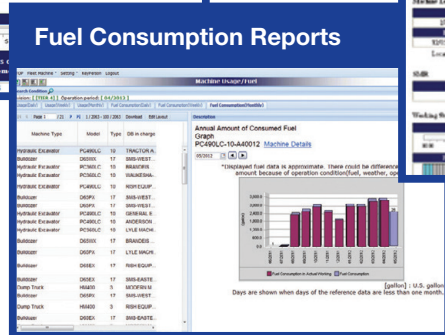
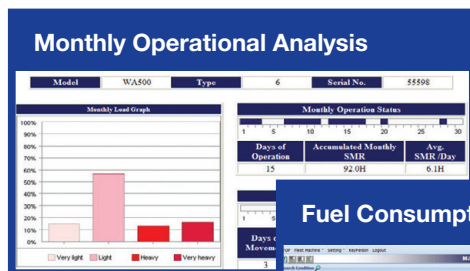

SPECIFICATIONS



ENGINE

Model..... Komatsu SAA6D140E-7*

Type..... Water-cooled, 4-cycle

Aspiration..... Variable geometry, turbo-charged, air-to-air after-cooled, cooled Exhaust Gas Recirculation (EGR)

Number of cylinders..... 6

Bore..... 140 mm **5.5"**

Stroke..... 165 mm **6.5"**

Piston displacement..... 15.24 ltr **930 in³**

Horsepower:

SAE J1995..... Gross 386 kW **518 HP**

ISO 9249 / SAE J1349..... Net 383 kW **514 HP**

Rated rpm..... 2000 rpm

Fan drive type..... Hydraulic

Maximum torque..... 221 kg•m **1,600 ft lbs**

Fuel system..... Direct injection

Governor..... Electronically controlled

Lubrication system:

Method..... Gear pump, force-lubrication

Filter..... Full-flow type

Air cleaner..... Dry type with double elements and precleaner, plus dust evacuator

*EPA Tier 4 Final emissions certified



TRANSMISSION

Torque converter..... Three-elements, one-stage, two-phase

Transmission..... Full-automatic, planetary type

Speed range..... Seven speeds forward and one reverse

Lockup clutch..... Wet, single-disc clutch

Forward..... Torque converter drive in 1st gear, direct drive in 1st lockup and all higher gears

Reverse..... Torque converter drive

Shift control..... Electronic shift control with automatic clutch modulation in all gears

Maximum travel speed..... 68 km/h **42.3 mph**



AXLES

Rear axle..... Full-floating

Final drive type..... Planetary gear

Ratios:

Differential..... 3.125

Planetary..... 4.737



SUSPENSION SYSTEM

Independent, hydro-pneumatic suspension cylinder with fixed throttle to dampen vibration

Effective cylinder stroke (front suspension)..... 250 mm **9.8"**

Rear axle oscillation:

Oil stopper..... 6.8°

Mechanical stopper..... 8.1°



STEERING SYSTEM

Type..... Fully hydraulic power steering with two double-acting cylinders

Supplementary steering..... Automatic/manual controlled (meets ISO 5010, SAE J1511 and SAE J53)

Minimum turning radius..... 7.2 m **23' 7"**

Maximum steering angle..... 43°



CAB

Dimensions comply with ISO 3471 and SAE J1040-1988c ROPS (Roll-Over Protective Structure) standards.



MAIN FRAME

Type..... Box-sectioned structure



BRAKES

Brakes meet ISO 3450 and SAE 1473 standards.

Service brakes:

Front..... Dry type, single disc type full hydraulic

Rear..... Wet type, multiple disc type, full hydraulic

Parking brake..... Dry type, single disc type, spring operated, hydraulic releasing type

Retarder..... Oil-cooled, multiple-disc type

Secondary brake..... Manual pedal operation

When hydraulic pressure drops below the rated level, parking brake is automatically actuated

Brake surface:

Front..... 968 cm² **150 in²**

Rear..... 50847 cm² **7,881 in²**



BODY

Capacity:

Struck..... 16.9 m³ **22.1 yd³**

Heaped (2:1 SAE)..... 24 m³ **31.4 yd³**

Payload, maximum..... 36.5 metric tons **40.3 U.S. tons**

Material..... 130 kg/mm² **184,860 psi** high tensile strength steel

Structure..... V-shape body

Material thickness:

Bottom..... 16 mm **0.63"**

Front..... 12 mm **0.47"**

Sides..... 9 mm **0.35"**

Target area

(inside length x width)... 5515 mm x 3380 mm **18' 1" x 11' 1"**

Dumping angle..... 48°

Height at full dump..... 8030 mm **26' 4"**

Heating..... Exhaust heating



HYDRAULIC SYSTEM

Hoist cylinder..... Twin, two-stage telescopic type

Relief pressure..... 20.6 MPa 210 kg/cm² **2,990 psi**

Hoist time..... 10 sec



WEIGHT (APPROXIMATE)

Empty weight..... 34180 kg **75,354 lbs**

Max. gross vehicle weight:

Standard tire..... 70760 kg **155,999 lbs**

Not to exceed max. gross vehicle weight, including options, fuel and payload

Weight distribution:

Empty:

Front axle..... 56.5%

Rear axle..... 43.5%

Loaded:

Front axle..... 33.7%

Rear axle..... 66.3%



TIRES

Standard tires..... 18.00 R33



SERVICE REFILL CAPACITIES

Fuel tank..... 456 L **120.5 U.S. gal**

DEF tank..... 34.7 L **9.2 U.S. gal**

Engine oil..... 50 L **13.2 U.S. gal**

Torque converter, transmission and retarder cooling..... 112 L **29.6 U.S. gal**

Differential..... 45 L **11.9 U.S. gal**

Final drives (total)..... 30 L **7.9 U.S. gal**

Hydraulic system..... 120 L **31.7 U.S. gal**

Suspension (total)..... 44.2 L **11.7 U.S. gal**



DIMENSIONS

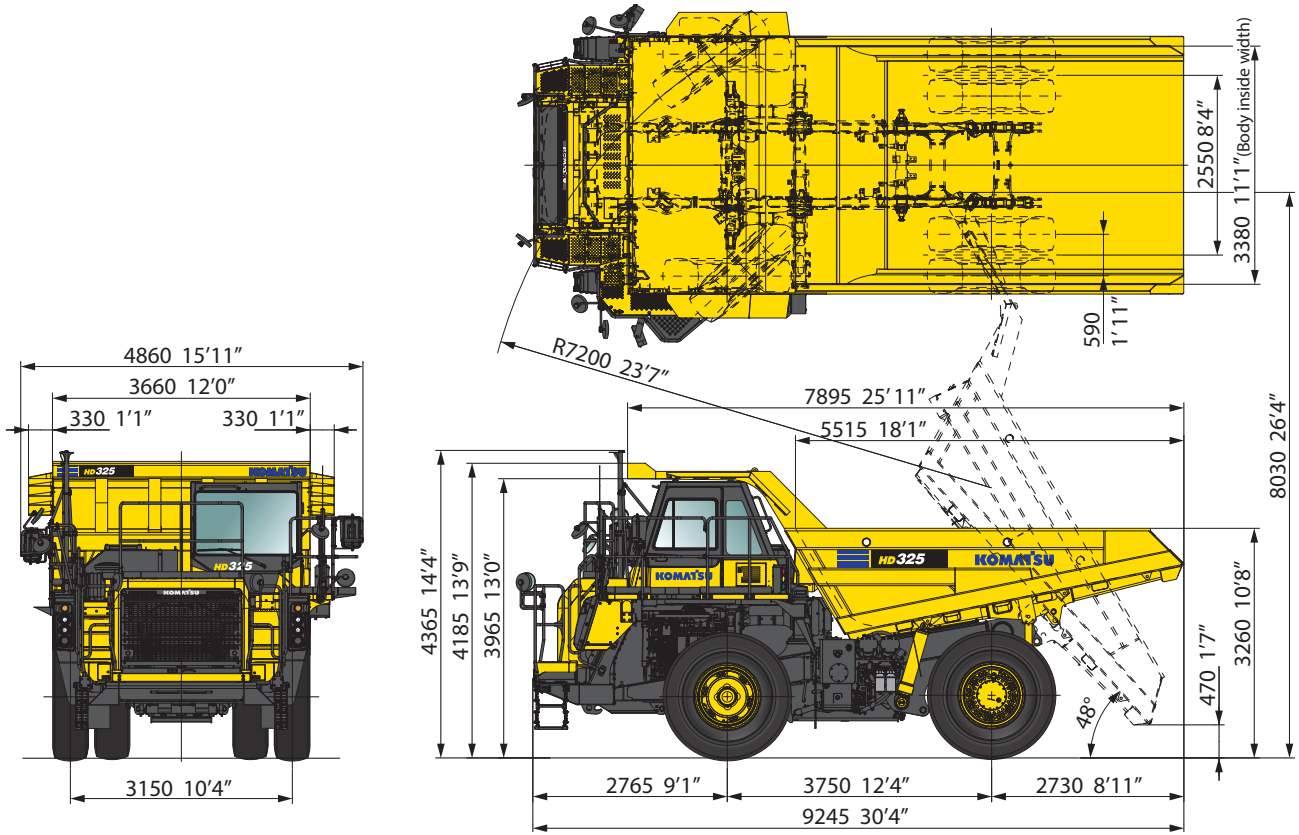

TRAVEL PERFORMANCE

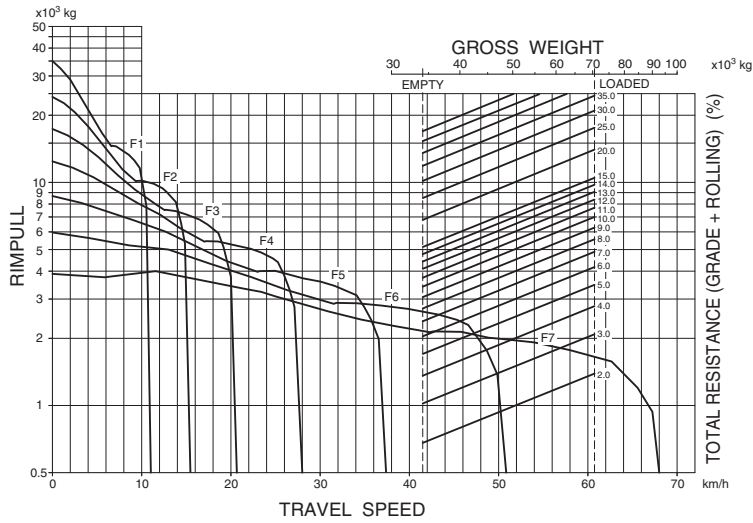

BRAKE PERFORMANCE

GRADE DISTANCE: CONTINUOUS DESCENT

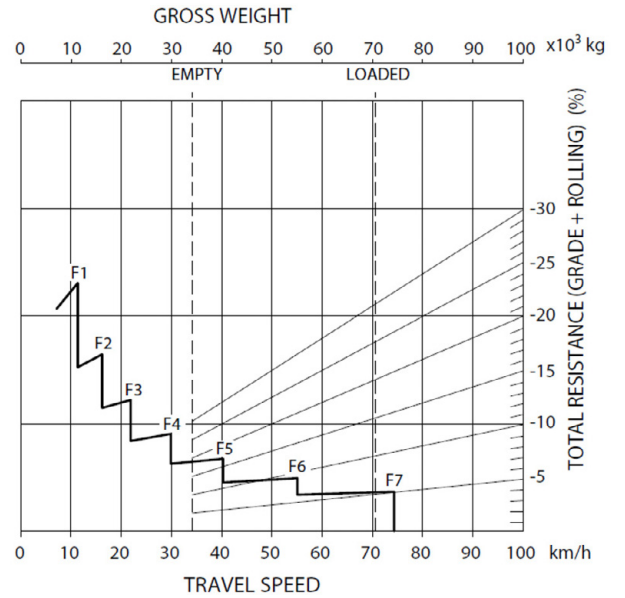



STANDARD EQUIPMENT FOR BASE MACHINE

ENGINE:

- Air cleaner, dry type, two stage
- Automatic Idling Setting System (AISS)
- Auto Idle Shutdown
- Electric priming fuel pump
- Engine secondary stop switch
- Engine, Komatsu SAA6D140E-7, six cylinder, turbocharged, air/air after-cooled, EGR cooled, diesel; Gross HP (SAE J1995): 518 HP (386 kW) / 2000 RPM; Net HP (ISO 9249/SAE J1349): 514 HP (383 kW) / 2000 RPM
- Fan, hydraulically driven, reversible
- Komatsu Diesel Particulate Filter (KDPF)
- Starting aid, intake manifold pre-heater
- Variable geometry turbocharger

ELECTRICAL SYSTEM:

- Alternator, 140 ampere, 24 volt
- Back-up alarm
- Batteries, 2 x 12 volt 160 Ah, 910 CCA
- Battery disconnect switch
- Emergency stop switch, ground level
- Horn, electric
- Lights
 - Back-up light, rear
 - Engine compartment light
 - Fog lights
 - Head lights, halogen (high and low beam)
 - Side working lights, LH and RH
 - Stop and tail lights (LED)
 - Turn signal, (two front, two rear, LED) with hazard switch
- Starter Isolator
- Starting motors, 11.0kW, 24V

POWER TRAIN AND CONTROLS:

- Seven-speed transmission, fully automatic with K-ATOMiCS
- Komatsu Traction Control System (KTCS)
- Front brake, dry type, single disc type, full hydraulic
- Parking brake, dry type, single disc type, spring operated, hydraulic released
- Rear brake, Wet type, multiple disc type, full hydraulic
- Skip shift function

OPERATOR ENVIRONMENT:

- Cab, with built in ROPS/FOPS
 - 12 Volt outlet (qty two)
 - Automatic climate control system with cab pressurization
 - Auxiliary steering system
 - Beverage holder (qty two)
 - Body hoist control, electric
 - Cigarette lighter and ashtray
 - Dome light and reading light
 - Door, LH and RH
 - Lunch box tray and storage trays
 - Machine monitor with seven-inch color LCD display
 - Operator seat, air suspension type, heated, ventilated, with three-point retractable seat belt (3" 75 mm wide lap belt and 2" 50 mm wide, high visibility shoulder belt)

- Power windows, LH and RH
- Radio, AM/FM with aux terminal
- Rearview mirror, outside cab mount, heated (LH & RH)
- Rearview monitoring system with dedicated monitor
- Steering wheel, tilt and telescopic
- Sun visor (qty two)
- Tinted glass (front, laminated glass)
- Trainer seat, folding, with two-point retractable seat belt (3" 75 mm wide)
- Wiper/washer, front, with intermittent setting

GUARD AND COVER GROUP:

- Catwalk with handrails
- Deck rail
- Driveline guards, front & rear
- Engine underguard
- Exhaust thermal guard
- Front handrail, over radiator
- Mudguards
- Transmission underguard

MONITORING SYSTEM, ELECTRONIC DISPLAY ITEMS:

- Instrument panel gauges
 - Coolant temperature
 - Hour meter (service meter)
 - Retarder oil temperature
 - Speedometer with odometer
 - Tachometer
 - Torque converter oil temperature
- Warning lights
 - DEF level
 - Engine coolant temperature
 - Engine coolant level
 - Engine oil pressure
 - Parking brake
 - Retarder oil temperature
 - Torque converter oil temperature

OTHER:

- Anchor points, tie off type (ISO 14567)
- Angled front stairs with hand rails
- Automatic retarder speed control (ARSC)
- Centralized lube block
- Dump counter
- Ecology guidance and ecology gauge
- Fast-fill coupler for fuel tank
- Filler cap and cover locks
- Front brake cut-off system
- Hydropneumatic suspension (front & rear)
- Less body (must select body)
- Mirror, rearview, underview
- PM service connectors
- Rock ejector bars
- KOMTRAX® telematics package with integrated payload meter (PLM)
- Wheel chocks with storage brackets



OPTIONAL EQUIPMENT

BODY:

- Alternative exhaust configuration (RH side discharge)
- Body
- Body liner

TIRES (18.00 R33):

- Michelin XHAUL
- Michelin X-Quarry
- Michelin XTRACTION
- Bridgestone VELS

AESS909-03

©2021 Komatsu America Corp.

Printed in USA

AD03(POD)

03/21 (EV-1)

KOMATSU®

Note: All comparisons and claims of improved performance made herein are made with respect to the prior Komatsu model unless otherwise specifically stated.

www.komatsuamerica.com

Komatsu America Corp. is an authorized licensee of Komatsu Ltd. Materials and specifications are subject to change without notice

KOMATSU®, Komatsu Care® and KOMTRAX® are registered trademarks of Komatsu Ltd.

All other trademarks and service marks used herein are the property of Komatsu Ltd., Komatsu America Corp. or their respective owners or licensees.

HD325-8